

## CARE AND MAINTENANCE

Spot clean using a mild water-free solvent. Only a professional cleaner should undertake a complete overall cleaning.

The use of steam or water-based cleaners may cause excessive shrinking or staining.







## NOTICE

\* Please make sure that you have all parts indicated before you begin assembly of this item

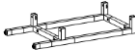
\* This item should be assembled on a soft surface to prevent scratching the finish during assembly

\* This item may require periodic tightening

## Part List and Hardware List

PIECE	DESCRIPTION	PICTURE	QUANTITY
A	FRAME		2X
B	GLASS		2X
C	ACRYLIC		4X
D	RUBBER MAT		8X
E	SOCKET HEAD SCREW		8X
F	ALLEN WRENCH		1X



Model#SFV2511A

Product Dimensions:47" W x 15.55" D 30" H

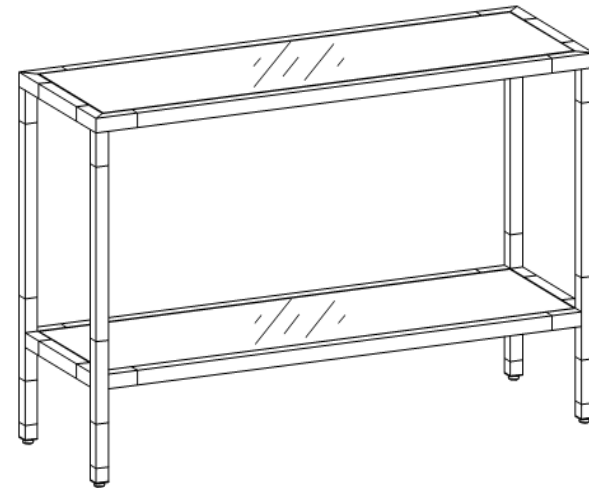

## PREPARATION

Before beginning assembly of product, make sure all parts are present. Compare parts with package contents list and hardware contents list.

If any part is missing or damaged, do not attempt to assemble the product.

Estimated Assembly Time: 30 minutes.

