

## CARE AND MAINTENANCE

Spot clean using soft cloth or an unused paint brush.

Only a professional cleaner should undertake a complete overall cleaning.

## NOTICE

- \* Place make sure that you have all parts indicated before your begin assembly of this item
- \* This item should be assembled on a soft surface to prevent scratching the finish during assembly
- \* This item may require periodic tightening

# SAFAVIEH









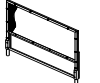

COU T U R E

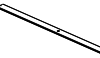
**SFV1302A-K**

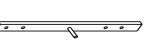
**DIMENSIONS: 80.71"x84.72"x56.81"**

**WEIGHT CAPACITY: 63.85 Kg**

### Part List and Hardware List

PIECE	PICTURE	DESCRIPTION	QTY
<b>A</b>		HEADBOARD	<b>1 PC</b>
<b>B</b>		FOOTBOARD	<b>1 PC</b>
<b>C</b>		SIDE RAILS	<b>2 PCS</b>
<b>D</b>		SLAT	<b>4 PCS</b>
<b>E</b>		CENTER LEG SUPPORT	<b>4 PCS</b>
<b>F</b>		WOODEN SUPPORT	<b>2 PCS</b>
<b>G</b>		WRENCH	<b>1 PC</b>
<b>H</b>		HEX NUT	<b>8 PCS</b>
<b>I</b>		LOCK WASHER	<b>8 PCS</b>
<b>J</b>		FLAT WASHER	<b>8 PCS</b>
<b>K</b>		THREADED ROD Ø 5/16" x 4"	<b>8 PCS</b>
<b>L</b>		1 1/2" SCREW	<b>16 PCS</b>

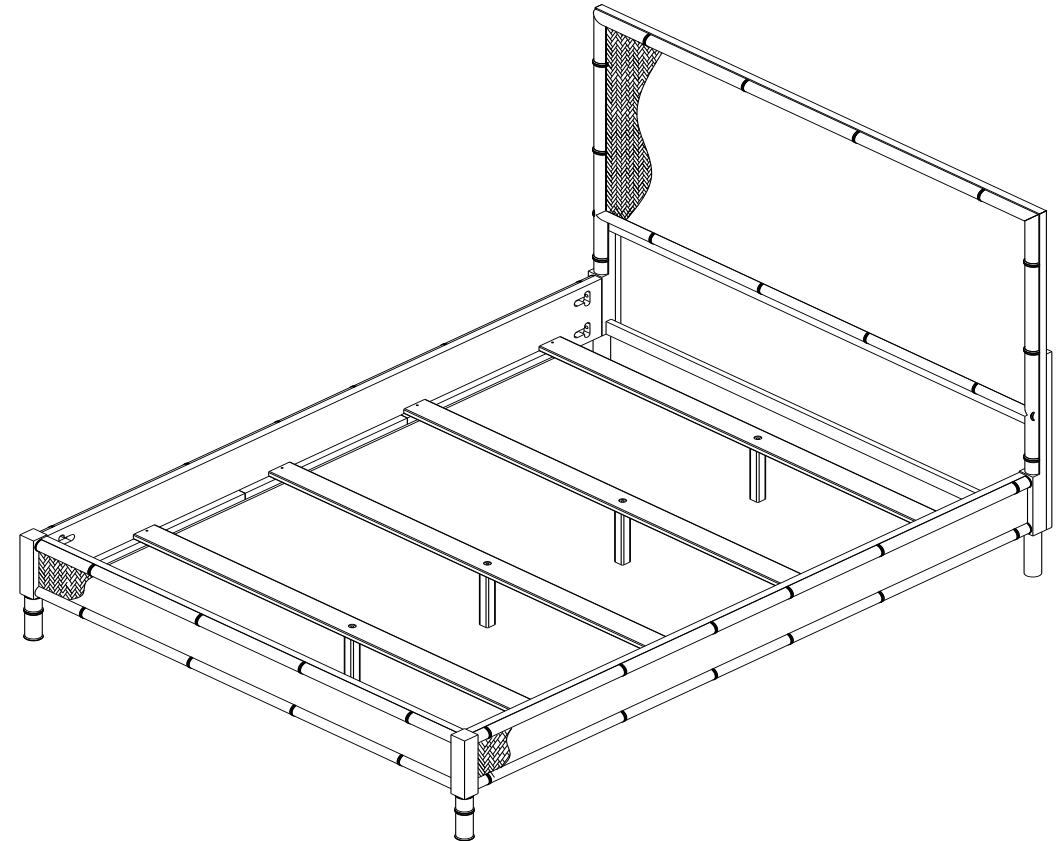

Weight Capacity: 550lbs

**WARNING: DO NOT STAND ON THE BED. DO NOT OVER TORQUE BOLTS AND SCREWS.**

## PREPARATION

Before beginning assembly of product, make sure all parts are present. Compare part with package contents list and hardware contents list. If any part is missing or damage, do not attempt to assemble the product.

Estimated Assembly Time: 10 minutes.

Tools Required for Assembly (included): Wrench

<p>Step 1. Install the wooden support on the back of the headboard panel.</p>	<p>Step 2. Attach the side rails to the headboard. Place the washers on the threaded rod in the order shown in the pictures.</p>	<p>Step 3. Attach the side rails to the footboard. Place the washers on the threaded rod in the order shown in the pictures.</p>

<p>Step 4. Insert bolted end of adjustable leveler into bottom of center support leg and twist until tight</p>	<p>Step 5. Place a slat 3" to 5" inward from each end of wood cleats. Place two slats between two ends slats so that there is an equal amount of space between all four slats and secure with wood screw provided.</p>

## CARE AND MAINTENANCE

Spot clean using soft cloth or an unused paint brush.

Only a professional cleaner should undertake a complete overall cleaning.

## NOTICE

- \* Place make sure that you have all parts indicated before your begin assembly of this item
- \* This item should be assembled on a soft surface to prevent scratching the finish during assembly
- \* This item may require periodic tightening

# SAFAVIEH









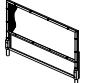
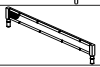

CO U T U R E

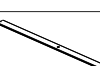
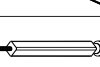
**SFV1302A-Q**

**DIMENSIONS: 65.72"x84.72"x56.81"**

**WEIGHT CAPACITY: 52.59 Kg**

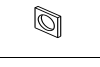
### Part List and Hardware List

PIECE	PICTURE	DESCRIPTION	QTY
<b>A</b>		HEADBOARD	<b>1 PC</b>
<b>B</b>		FOOTBOARD	<b>1 PC</b>
<b>C</b>		SIDE RAILS	<b>2 PCS</b>
<b>D</b>		SLAT	<b>4 PCS</b>
<b>E</b>		CENTER LEG SUPPORT	<b>4 PCS</b>
<b>F</b>		WOODEN SUPPORT	<b>2 PCS</b>
<b>G</b>		WRENCH	<b>1 PC</b>
<b>H</b>		HEX NUT	<b>8 PCS</b>
<b>I</b>		LOCK WASHER	<b>8 PCS</b>
<b>J</b>		FLAT WASHER	<b>8 PCS</b>
<b>K</b>		THREADED ROD Ø 5/16" x 4"	<b>8 PCS</b>
<b>L</b>		1 1/2" SCREW	<b>16 PCS</b>

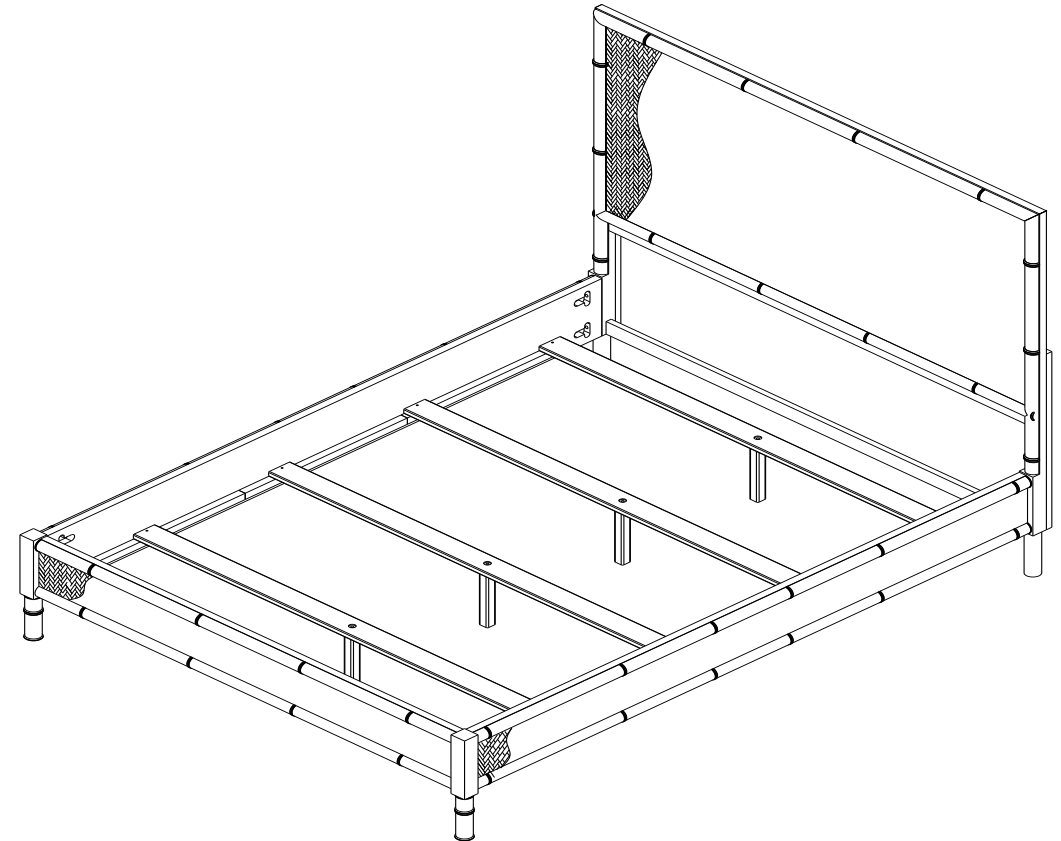

Weight Capacity: 550lbs

**WARNING: DO NOT STAND ON THE BED. DO NOT OVER TORQUE BOLTS AND SCREWS.**

## PREPARATION

Before beginning assembly of product, make sure all parts are present. Compare part with package contents list and hardware contents list.

If any part is missing or damage, do not attempt to assemble the product.

Estimated Assembly Time: 10 minutes.

Tools Required for Assembly (included): Wrench

<p>Step 1. Install the wooden support on the back of the headboard panel.</p>	<p>Step 2. Attach the side rails to the headboard. Place the washers on the threaded rod in the order shown in the pictures.</p>	<p>Step 3. Attach the side rails to the footboard. Place the washers on the threaded rod in the order shown in the pictures.</p>

<p>Step 4. Insert bolted end of adjustable leveler into bottom of center support leg and twist until tight</p>	<p>Step 5. Place a slat 3" to 5" inward from each end of wood cleats. Place two slats between two ends slats so that there is an equal amount of space between all four slats and secure with wood screw provided.</p>