

SAFAVIEH LIGHTING

Assembly Instruction

CAUTION: Read instruction carefully and turn electricity off at main circuit breaker panel before beginning installation.

ITEM #:PND4115A

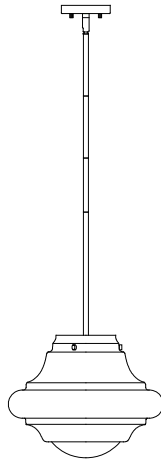

Care and Cleaning







To clean the outside of the fixture, use a dry or slightly dampened clean cloth (use clean water, never a solvent) to wipe the surface of the fixture.

To clean the inside of the fixture, first disconnect power to the fixture by turning off the circuit breaker or by removing the fuse at the fuse box. Next, use a dry or slightly dampened clean cloth (use clean water, never a solvent) to wipe the interior surface of the fixture.

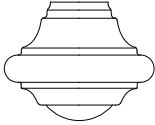
Do not use any cleaners with chemical, solvents or harsh abrasives. Use Only a dry soft cloth to dust or wipe carefully.

Estimated Assembly Time: 30 minutes

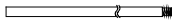
Part List and Hardware List

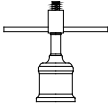
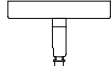
PIECE	DESCRIPTION	PICTURE	QUANTITY	PIECE	DESCRIPTION	PICTURE	QUANTITY
A	Crossbar		1X	D	Glass shade		1X
A1	Junction box screw		2X				
A2	Canopy nut		2X	E	Screw		3X
B	Bulb		1X	F	12" tube		2X
B1	Wire Nut		3X	G	6" tube		2X
C	Light fixture		1X	H	Canopy unit		1X

Installation

Step 1

Raise the tube (F) to the top pipe thread of light fixture (C), by turning it clockwise until tight. Raise the tubes(F1)/(G) and canopy unit(H) to the pipe thread in order, then by turning it clockwise until tight.

Place the bulb (B) to the socket

Attach the glass shade (D) to the light fixture (C) with screw (E).

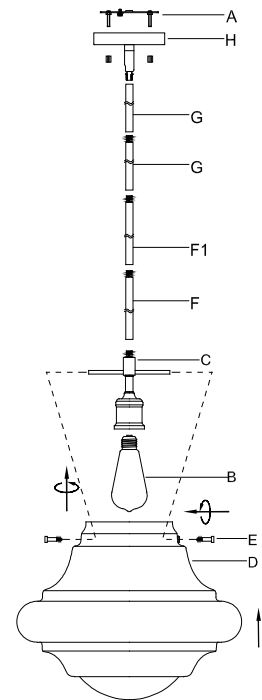

*Note:PLEASE USE ON/OFF TYPE"A" BULB MAX 40-WATT
OR CFL BULB MAX 13-WATT
OR LED BULB MAX 4-WATT
THERE IS LED 9-WATT BULB IN THE BOX

Step 2 Wire Connection

Connect,Hot,Black or Red outlet Supply Wire to:	Connect,Neutral,White Outlet Supply Wire to:
Black	White
* Parallel Cord(round & smooth)	* Parallel Cord(square& ridged)
Clear,Brown,Gold or Black without Tracer(colored stripes)	Clear,Brown,Gold or Black without Tracer(colored stripes)
Insulated Wire(not green) with copper metal conductor	Insulated Wire(not green) with Silver metal conductor

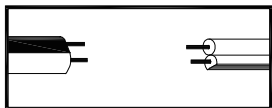

*Note: When parallel wire(SPT I & SPT II) is used.The neutral wire is square shaped and ridged and the hot wire will be round in shape and smooth.(See illustration on left.)

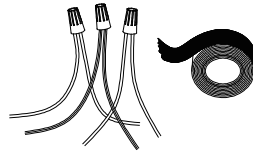

Grounding Instructions:

- For installation in the United States: Wrap ground wire from outlet box around green ground screw on mounting bracket, no less than 2" from wire end. Tighten ground screw. If fixture is supplied with a ground wire, connect to outlet ground wire with a wire connector.
- For installation in Canada: If fixture is supplied with ground wire, wrap ground wire around green grounding screw on mounting bracket. Tighten ground screw.

Step 3

Attach the crossbar (A) to the junction box with junction box screw (A1).

Install canopy (H) onto the junction box, aligning screw hole on crossbar with mounting holes in canopy and lock it securely with the canopy nut (A2)

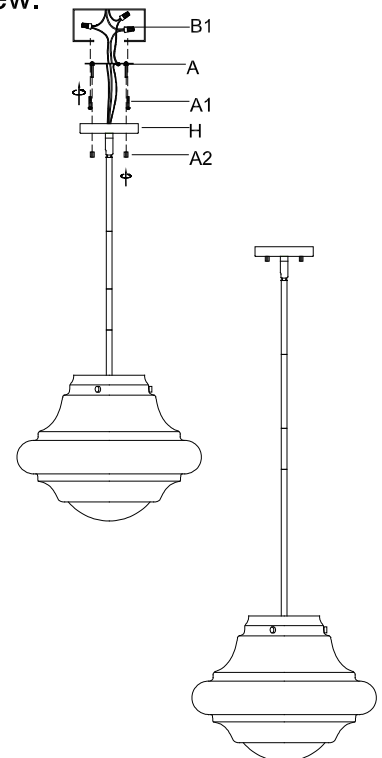

Step 4

Consult a qualified electrician to ensure correct branch circuit conductor

ENJOY YOUR LAMP