

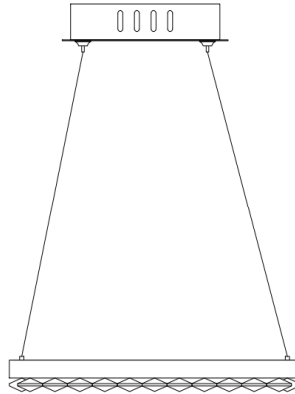

Assembly Instruction

CAUTION: Read instruction carefully and turn electricity off at main circuit breaker panel before beginning installation.

ITEM#:PND4102A



Care and Cleaning









To clean the outside of the fixture, use a dry or slightly dampened clean cloth(use clean water, never a solvent) to wipe the surface of the fixture.

To clear the inside of the fixture, first disconnect power to the fixture by turning off the circuit breaker or by removing the fuse at the fuse box. Next, use a dry or slightly dampened clean cloth(use clean water, never a solvent) to wipe the interior surface of the fixture

Do not use any cleaners with chemical, solvents or harsh abrasives. Use Only a dry soft cloth to dust or wipe carefully.

Estimated Assembly Time:30 minutes

Part List and Hardware List

| PIECE | DESCRIPTION | PICTURE | QUANTITY | PIECE | DESCRIPTION | PICTURE | QUANTITY |
|-------|------------------|---|----------|-------|-------------|---|----------|
| A | mounting screw |  | 2X | F | wire |  | 3X |
| B | mounting bracket |  | 1X | G | regulator |  | 3X |
| C | machine screw |  | 2X | H | canopy |  | 1X |
| D | wire connector |  | 3X | I | lamp body |  | 1X |
| E | driver |  | 1X | | | | |

Before beginning assembly of product, make sure all parts are present. Compare parts with package contents list and hardware contents list. If any part is missing or damaged, do not attempt to assemble the product.
 Estimated Assembly Time: 20 minutes.

1. Take out machine screw (C) and mounting bracket (B) from canopy (H)
2. Fix the mounting bracket (B) to the outlet box with machine screw (C).
3. Make wire connections, with wire connectors (D), following the reference chart listed below.

| Connect, Hot, Black or Red Outlet Supply Wire to: | Connect, Neutral, White Outlet Supply Wire to: |
|--|---|
| Black | White |
| * Parallel Cord (round & smooth) | * Parallel Cord (square & ridged) |
| Clear, Brown, Gold or Black without Tracer (colored stripes) | Clear, Brown, Gold or Black with Tracer (colored stripes) |
| Insulated Wire (not green) with copper metal conductor | Insulated Wire (not green) with Silver metal conductor. |

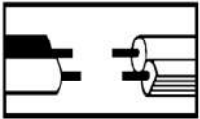

*Note: When parallel wire (SPT I & SPT II) is used. The neutral wire is square shaped and ridged and the hot wire will be round in shape and smooth. (See Illustration on left.)

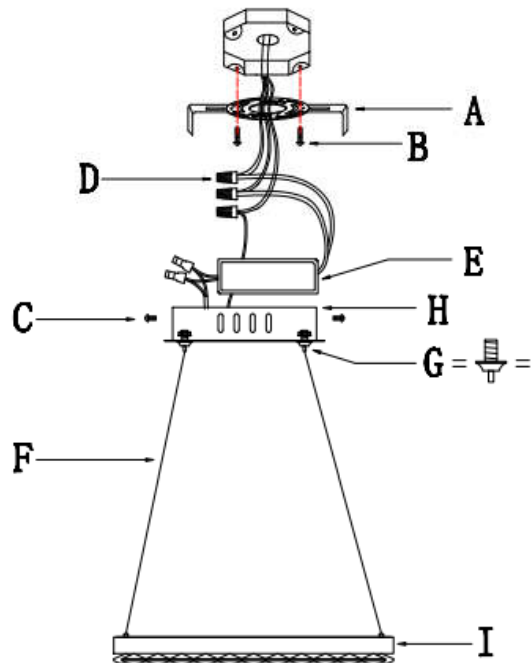

Grounding Instructions:

- a) For installation in the United States: Wrap ground wire from outlet box around green ground screw on mounting bracket, no less than 2" from wire end. Tighten ground screw. If fixture is supplied with a ground wire, connect to outlet ground wire with a wire connector.
 - b) For installation in Canada: If fixture is supplied with ground wire, wrap ground wire around green grounding screw on mounting bracket. Tighten ground screw.
4. Fix the ceiling canopy (H), orient the canopy to make the canopy hole to match the bracket hole then secure it with the mounting screw (A).
 5. Use regulator (G) to adjust long of wire, put the wire into regulator (G) can be shorter, press regulator (G) and take out wire from regulator (G) can be longer.
 6. Turn on switch, light up.

ENJOY YOUR LAMP