

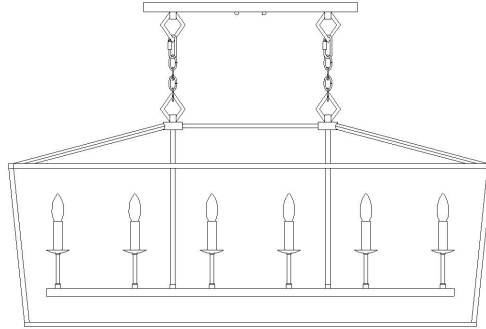

## Assembly Instruction

**CAUTION:** Read instruction carefully and turn electricity off at main circuit breaker panel before beginning installation.

**ITEM#:PND4088A**



### Care and Cleaning











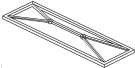





To clean the outside of the fixture, use a dry or slightly dampened clean cloth (use clean water, never a solvent) to wipe the surface of the fixture.

To clear the inside of the fixture, first disconnect power to the fixture by turning off the circuit breaker or by removing the fuse at the fuse box. Next, use a dry or slightly dampened clean cloth (use clean water, never a solvent) to wipe the interior surface of the fixture.

Do not use any cleaners with chemical, solvents or harsh abrasives. Use Only a dry soft cloth to dust or wipe carefully.

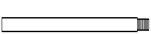
Estimated Assembly Time: 30 minutes

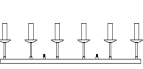
### Part List and Hardware List

PIECE	DESCRIPTION	PICTURE	QUANTITY	PIECE	DESCRIPTION	PICTURE	QUANTITY
A	Conical frame		1X	J	Screwed Ball		2X
B	Frame support rod		4X	K	Chain		2X
C	Rectangular frame		1X	L	Bulb		6X
D	Flat head Phillips screw		16X	O	Mounting bracket		1X
E	Loop		4X	P	Machine Screw		2X
F	Rubber gasket		2X	Q	Machine Screw		2X
G	Hang rod		2X	S	Ground screw		1X
H	Lamp holder		1X	T	Wire connector		3X
I	Canopy		1X				

# Installation

## Step 1

Fixed Conical frame(A)and Rectangular frame(C) with Frame support rod(B) by Flat head Phillips screw(D)

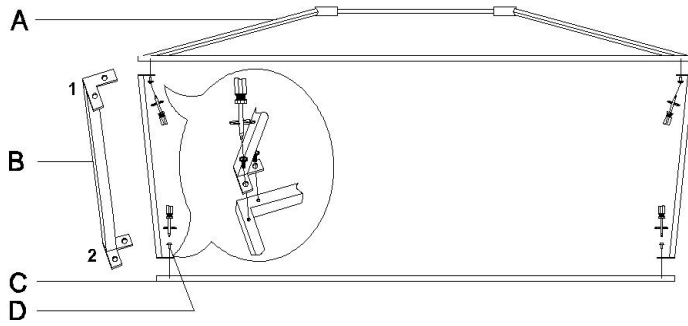

## Step 2

Pass the wire through the hang loop(G),fix it on lamp holder(H) by clockwise rotation.Then continue to pass the wire through top frame, rubber gasket(F) and loop(E).Rotated loop(E) by clockwise to fix lamp holder(H) and lamp body frame.

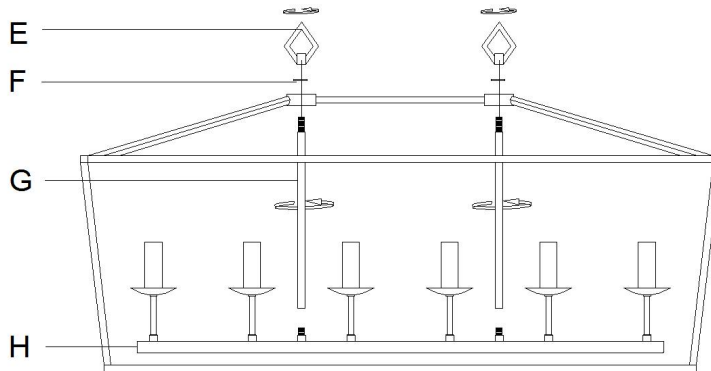

## Step 3

Used Chain(K) to connect the canopy (l) with lamp bady ,then pass the wire through Chain(K) to canopy(l).

## Step 4

Install the mounting braket(O) to the junction box with machine screw (P).

## Step5

Make wire connections, with wire connectors(T), following the reference chart listed below.

Connect,Hot,Black or Red outlet Supply Wire to:	Connect,Neutral,White Outlet Supply Wire to:
Black	White
*Parallel Cord(round&smooth)	*Parallel Cord(square&ridged)
Clear,Brown,Gold or Black without Tracer(colored stripes)	Clear,Brwn,Gold or Black without Tracer(colored stripes)
Insulated Wire(not green)with copper metal conductor	Insulated Wire(not green)with Silver metal conductor

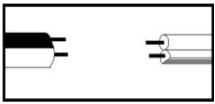

\*Note: When parallel wire(SPTI&SPTII)is used. The neutral wire is square shaped and ridged and the hot wire will be round in shape and smooth.(See illustration on left)

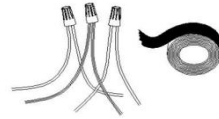

**Grounding Instructions:**

a) For installation in the United States: Wrap ground wire from outlet box around green ground screw on mounting bracket, no less than 2" from wire end. Tighten ground screw. If fixture is supplied with a ground wire, connect to outlet ground wire with a wire connector.

b) For installation in Canada: If fixture is supplied with ground wire, wrap ground wire around green grounding screw on mounting bracket. Tighten ground screw.

**Step 6**

Fixed the canopy(I) with mounting bracket(O)by screwed ball(J).

**Step 7**

Install bulb(L). Be sure to use light bulb(s) with wattage no greater than specified on this fixture. Always make sure that electrical current is turned off before changing bulbs.

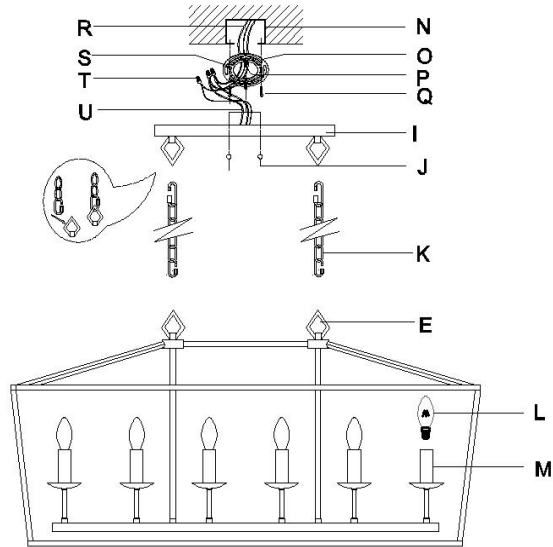

**PLEASE USE TYPE"B" BULB MAX 40-WATT OR CFL BULB MAX 13-WATT OR LED BULB MAX 9-WATT  
THERE ARE 6PCS LED 4 WATT BULB IN THE BOX**

Consult a qualified electrician to ensure correct branch circuit conductor.

ENJOY YOUR LAMP