



SAFAVIEH

LIGHTING

Assembly Instruction

CAUTION: Read instruction carefully and turn electricity off at main circuit breaker panel before beginning installation.

ITEM#:PND4036A

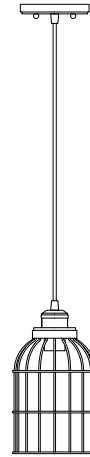

Care and Cleaning







To clean the outside of the fixture, use a dry or slightly dampened clean cloth(use clean water, never a solvent)to wipe the surface of the fixture.

To clear the inside of the fixture, first disconnect power to the fixture by turning off the circuit breaker or by removing the fuse at the fuse box. Next, use a dry or slightly dampened clean cloth(use clean water, never a solvent) to wipe the interior surface of the fixture

Do not use any cleaners with chemical, solvents or harsh abrasives. Use Only a dry soft cloth to dust or wipe carefully.

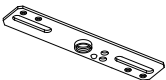
Estimated Assembly Time:30 minutes

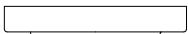
Part List and Hardware List

PIECE	DESCRIPTION	PICTURE	QUANTITY	PIECE	DESCRIPTION	PICTURE	QUANTITY
A	mounting screw		2X	E	screwed ball		2X
B	mounting bracket		1X	F	ground screw		1X
C	machine screw		2X	G	canopy		1X
D	wire connector		3X	H	bulb		1X

Installation

Step 1

Unpack all parts from cartons carefully.

1. Fix the mounting bracket(B) to the outlet box with machine screw(C).

Attach the Canopy(G) to the Mounting bracket (B) and fix it by turning the screwed ball (E).

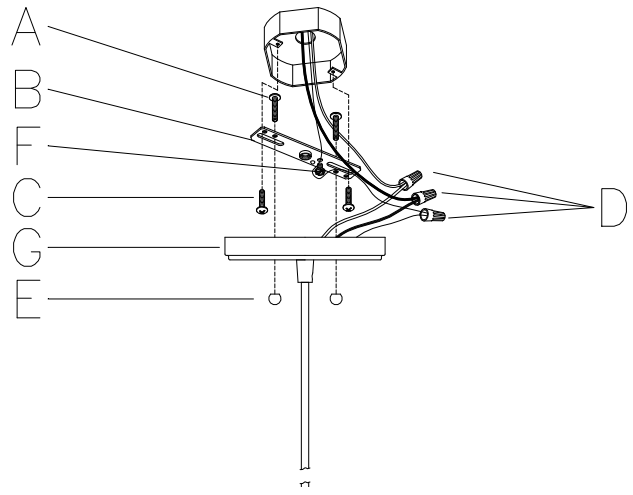

Step 2 Wire connection

Make wire connections, with wire connectors(D), following the reference chart listed below.

Connect,Hot,Black or Red outlet Supply Wire to:	Connect,Neutral,White Outlet Supply Wire to:
Black	White
*Parallel Cord(round&smooth)	*Parallel Cord(square&ridged)
Clear,Brown,Gold or Black without Tracer(colored stripes)	Clear,Brwn,Gold or Black without Tracer(colored stripes)
Insulated Wire(not green)with copper metal conductor	Insulated Wire(not green)with Silver metal conductor

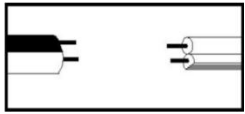

*Note: When parallel wire(SPTI&SPTII)is used. The neutral wire is square shaped and ridged and the hot wire will be round in shape and smooth.(See illustration on left)

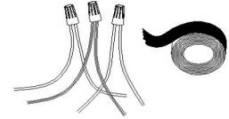

Grounding Instructions:

- For installation in the United States: Wrap ground wire from outlet box around green ground screw on mounting bracket, no less than 2" from wire end. Tighten ground screw. If fixture is supplied with a ground wire, connect to outlet ground wire with a wire connector.
- For installation in Canada: If fixture is supplied with ground wire, wrap ground wire around green grounding screw on mounting bracket. Tighten ground screw.

Step 3

Install bulbs(H). Be sure to use light bulb(s) with wattage no greater than specified on this fixture. Always make sure that electrical current is turned off before changing bulbs.

**PLEASE USE TYPE "A" BULB MAX 60-WATT OR EDISON BULBE MAX 60-WATT OR CFL BULB MAX 13-WATT OR LED MAX 9-WATT
THERE IS 1PC LED BULB 4-WATT IN THE BOX.**

Step 4

Consult a qualified electrician to ensure correct branch circuit conductor

ENJOY YOUR LAMP

