

SAFAVIEH LIGHTING

Assembly Instruction

CAUTION: Read instruction carefully and turn electricity off at main circuit breaker panel before beginning installation.

ITEM#: PND4021A

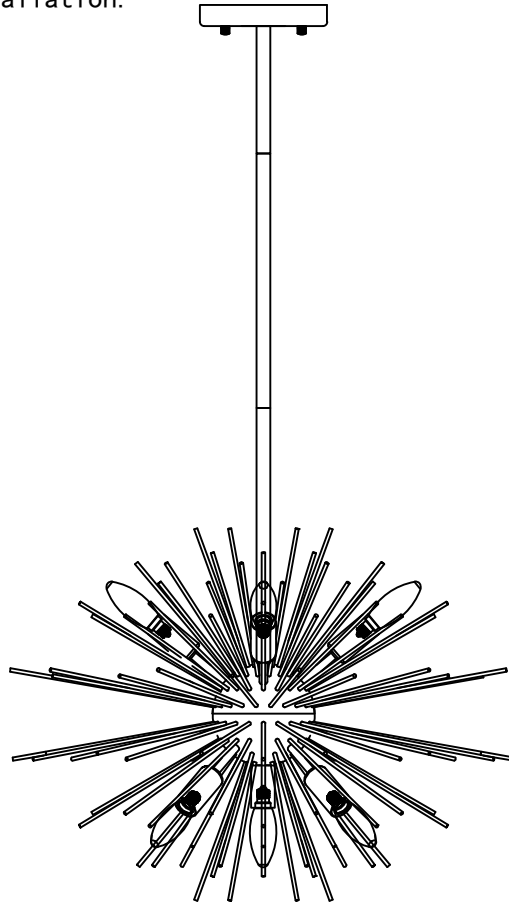

Care and Cleaning





To clean the outside of the fixture, use a dry or slightly dampened clean cloth (use clean water, never a solvent) to wipe the surface of the fixture.





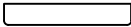

To clear the inside of the fixture, first disconnect power to the fixture by turning off the circuit breaker or by removing the fuse at the fuse box. Next, use a dry or slightly dampened clean cloth (use clean water, never a solvent) to wipe the interior surface of the fixture.

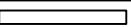
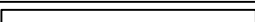
Do not use any cleaners with chemical, solvents or harsh abrasives. Use Only a dry soft cloth to dust or wipe carefully.

Estimated Assembly Time: 30 minutes

Part List and Hardware List

PIECE	DESCRIPTION	PICTURE	QUANTITY
A	Mounting Plate		1X
B	Mounting Screw M4*L30		2X
C	Orange Nut		3X
D	Canopy		1X
E	Nut		2X
G	Boom		2X
H	Boom		2X

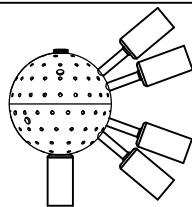
PIECE	DESCRIPTION	PICTURE	QUANTITY
I	250mm Pontil a		18X
	210mm Pontil b		32X
	180mm Pontil c		24X
	150mm Pontil d		10X
J	Mounting Screw M4*18		2X
K	Bulb		9X
L			1

Installation

Step 1

Unpack all parts from cartons carefully.

Place the Canopy (D) onto the Boom (G)

Place the tube of Mounting Plate (A) into the threaded portion

Place the Mounting Screw (B) onto the Nut (E) and fix it by turning the Boom (G) clockwise till tight.

Attach the Boom (H) onto the Boom (G)

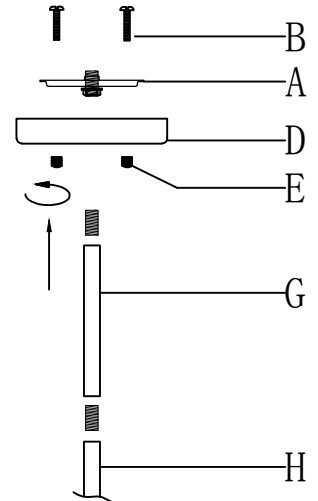

Step 2

Tighten the Pontil (I) to lamp (J).
From Round 1 to Round

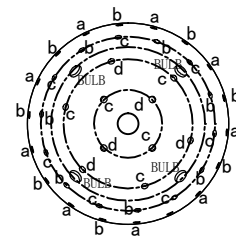
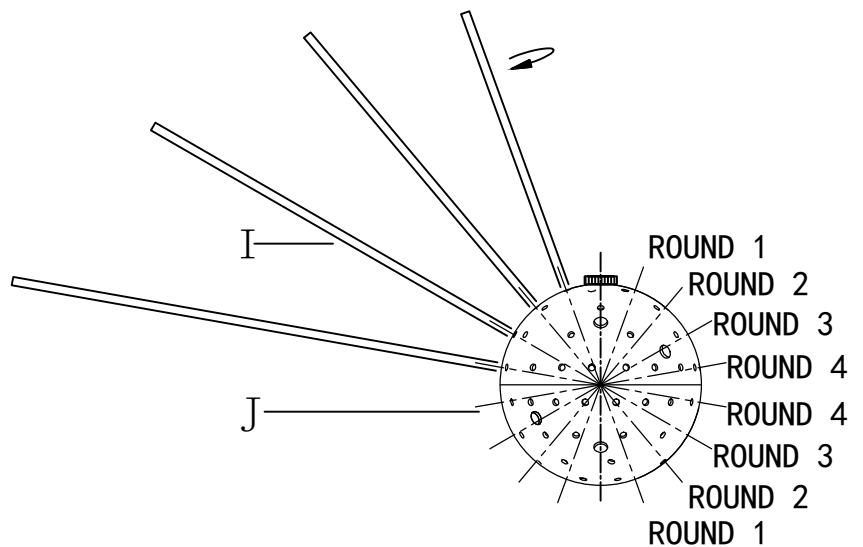
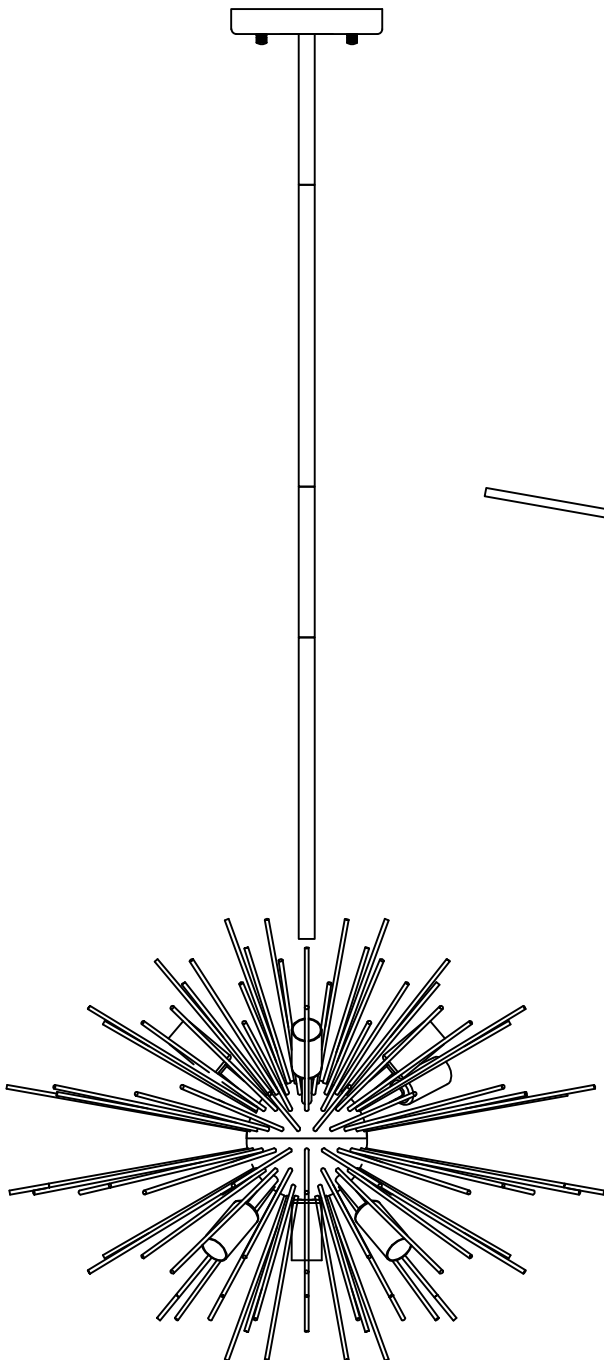

(a b c d) is the holes for Pontil (I)
Remark BULB is for sockets.
From center to outer is one to one
correspondence Round 1 to Round 4.

Step 3 Wire connection

Connect, Hot, Black or Red outlet Supply Wire to:	Connect, Neutral, White Outlet Supply Wire to:
Black	White
*Parallel Cord (round&smooth)	*Parallel Cord (square&ridged)
Clear, Brown, Gold or Black without Tracer (colored stripes)	Clear, Brwn, Gold or Black without Tracer (colored stripes)
Insulated Wire (not green) with copper metal conductor	Insulated Wire (not green) with Silver metal conductor

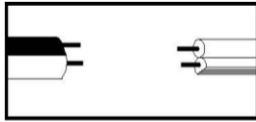

*Note: When parallel wire (SPTI&SPTII) is used. The neutral wire is square shaped and ridged and the hot wire will be round in shape and smooth. (See illustration on left)

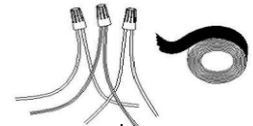

Grounding Instructions:

- For installation in the United States: Wrap ground wire from outlet box around green ground screw on mounting bracket, no less than 2" from wire end. Tighten ground screw. If fixture is supplied with a ground wire, connect to outlet ground wire with a wire connector.
- For installation in Canada: If fixture is supplied with ground wire, wrap ground wire around green grounding screw on mounting bracket. Tighten ground screw.

Step 4

Separate the Mounting Plate (A) from the Canopy (D) anti-clockwise.

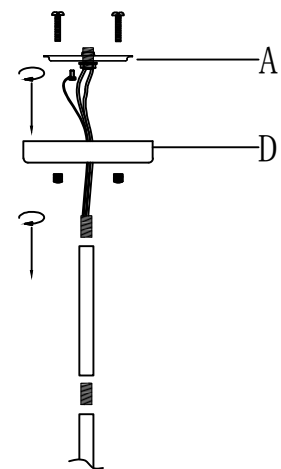

Step 5

Install the Mounting Plate (A) to the junction box with Mounting Screw (C)
 Attach the Canopy (D) to the junction box and fix it clockwise
 Insert the bulbs (K) into the Sockets

PLEASE USE TYPE "B" BULB MAX 40-WATT OR CFL BULB MAX 13-WATT OR LED BULB MAX 9-WATT
 THERE ARE 9PCS LED 4-WATT BULBS IN THE BOX

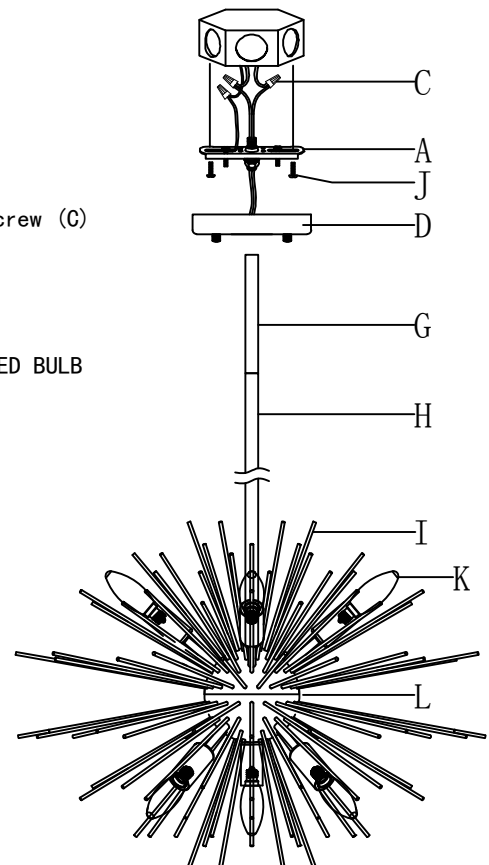

Step 6

Consult a qualified electrician to ensure correct branch circuit conductor.

ENJOY YOUR LAMP