



SAFAVIEH LIGHTING

Assembly Instruction

CAUTION: Read instruction carefully and turn electricity off at main circuit breaker panel before beginning installation.

ITEM#:PND4001A



Care and Cleaning















To clean the outside of the fixture, use a dry or slightly dampened clean cloth(use clean water, never a solvent)to wipe the surface of the fixture.

To clear the inside of the fixture, first disconnect power to the fixture by turning off the circuit breaker or by removing the fuse at the fuse box. Next, use a dry or slightly dampened clean cloth(use clean water, never a solvent) to wipe the interior surface of the fixture

Do not use any cleaners with chemical, solvents or harsh abrasives. Use Only a dry soft cloth to dust or wipe carefully.

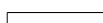
Estimated Assembly Time:30 minutes

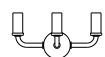
Part List and Hardware List

PIECE	DESCRIPTION	PICTURE	QUANTITY	PIECE	DESCRIPTION	PICTURE	QUANTITY
A	mounting bracket		1X	I	ring nut		1X
B	mounting screw		2X	J	bulb		4X
C	threaded rod		1X	K	crystal		48X+ (1X spare)
D	wire connector		3X	L	screwed ball		48X + (1X spare)
E	collar loop		1X	M	collar loop ring		1X
F	canopy		1X	N	tube		1X
G	chain		1X	O	lamp body		1X
H	fixture loop		4X				

Installation

Step 1

- Unpack all parts from cartons carefully.
- To make sure the wire go through the chain (G),
- Fix tube (N) to lamp body (O)
- Fix ring nut (I) to tube(N)
- Screw the fixture loop(H)to ring nut(I).

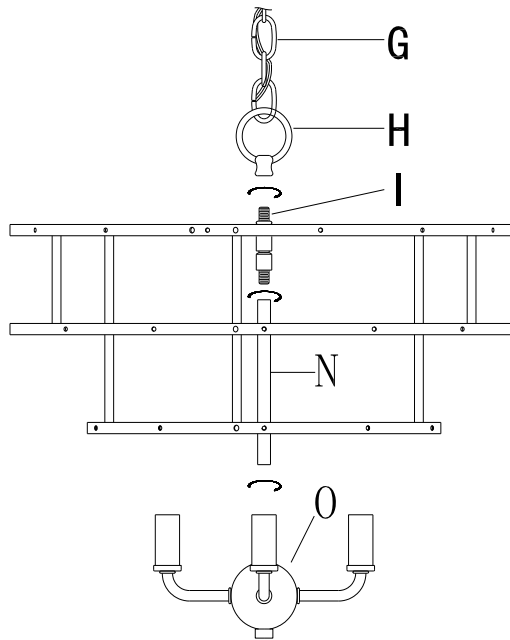

Step 2

- Fix the mounting bracket(A)to outlet box with mounting screw(B)
- Raise the canopy(F) to the ceiling and then secure it by fixing the the collar loop(E) with collar loop ring (M)to the threaded rod(C)

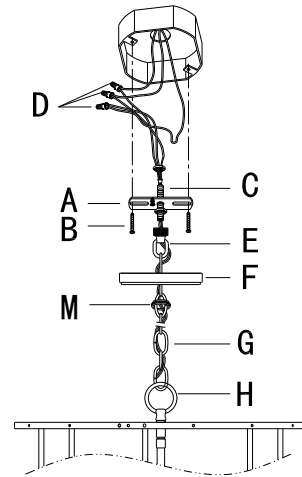

Step 3 Wire connection

Connect,Hot,Black or Red outlet Supply Wire to:	Connect,Neutral,White Outlet Supply Wire to:
Black	White
*Parallel Cord(round&smooth)	*Parallel Cord(square&ridged)
Clear,Brown,Gold or Black without Tracer(colored stripes)	Clear,Brwn,Gold or Black without Tracer(colored stripes)
Insulated Wire(not green)with copper metal conductor	Insulated Wire(not green)with Silver metal conductor

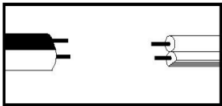

*Note: When parallel wire(SPTI&SPTII)is used. The neutral wire is square shaped and ridged and the hot wire will be round in shape and smooth.(See illustration on left)

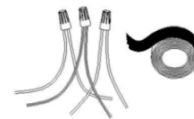

Grounding Instructions:

- For installation in the United States: Wrap ground wire from outlet box around green ground screw on mounting bracket, no less than 2" from wire end. Tighten ground screw. If fixture is supplied with a ground wire, connect to outlet ground wire with a wire connector.
- For installation in Canada: If fixture is supplied with ground wire, wrap ground wire around green grounding screw on mounting bracket.Tighten ground screw.

Step 4

Install the bulb(J) Screw the crystal(K)to
Screw the crystal(K)to the frame with scrwed ball(L)

**PLEASE USE ON/OFF TYPE "B" BULB
MAX 40-WATTOR CFL BULB MAX 9-WATT
THERE ARE 4PCS TYPE "B" 25-WATT BULB IN THE BOX**

Step5

Consult a qualified electrician to
ensure correct branchcircuit conductor

ENJOY YOUR LAMP

