

CARE AND MAINTENANCE









Spot clean using a mild water-free solvent. Only a professional cleaner should undertake a complete overall cleaning.

The use of steam or water-based cleaners may cause excessive shrinking or staining.

NOTICE

- * Please make sure that you have all parts indicated before you begin assembly of this item
- * This item should be assembled on a soft surface to prevent scratching the finish during assembly y
- * This item may require periodic tightening

Part List And Hardware List

PIECE	DESCRIPTION	PICTURE	QUANTITY
A	Chair		2
B	Front Chair Leg		4
C	Rear Chair Leg		4
D	Cushion		2
E	Table Top		1
F	Table leg		4
G	Table glass		1
HW1	Bolt and washer M6x15		40
HW2	Allen Key		1



ITEM NO.:PAT9013

ProductDimensions:
 Chair: W21.1"*D23.6"*H32.3"
 Side Table: φ20.1"*H20.1"
 Weight Capacity:
 Chair: 220lbs
 Table: 110lbs

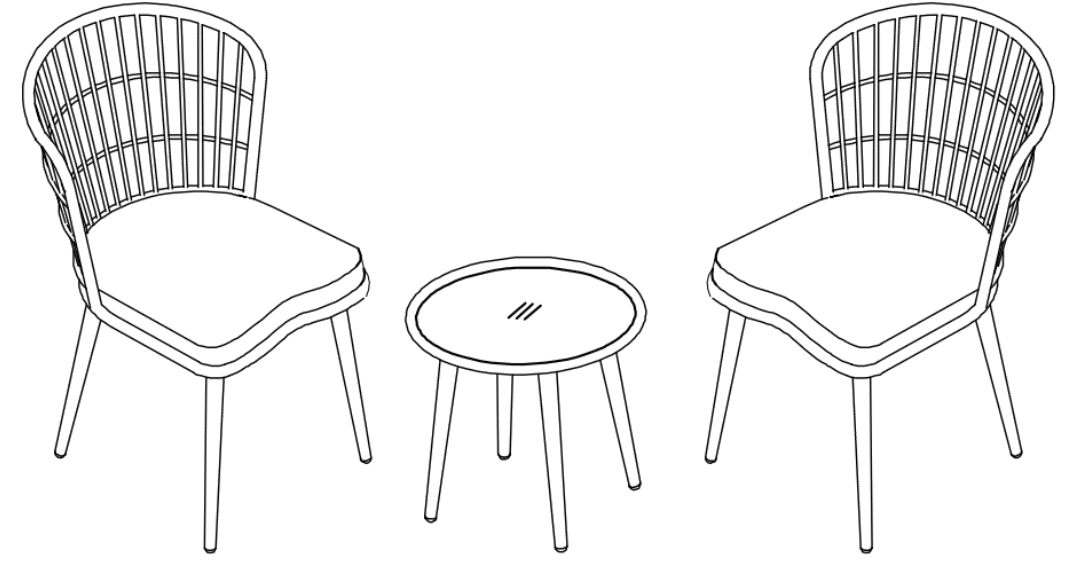

PREPARATION

Before beginning assembly of product, make sure all parts are present. Compare parts with package contents list and hardware contents list. If any part is missing or damaged, do not attempt to assemble the product.

Estimated Assembly Time: 45 minutes.

Tools Required for Assembly (included): Allen Key

Gradually tighten bolts in a star pattern: tighten one bolt and then the one opposite from it until all bolts are tightened.

Chair Assemble

STEP 1

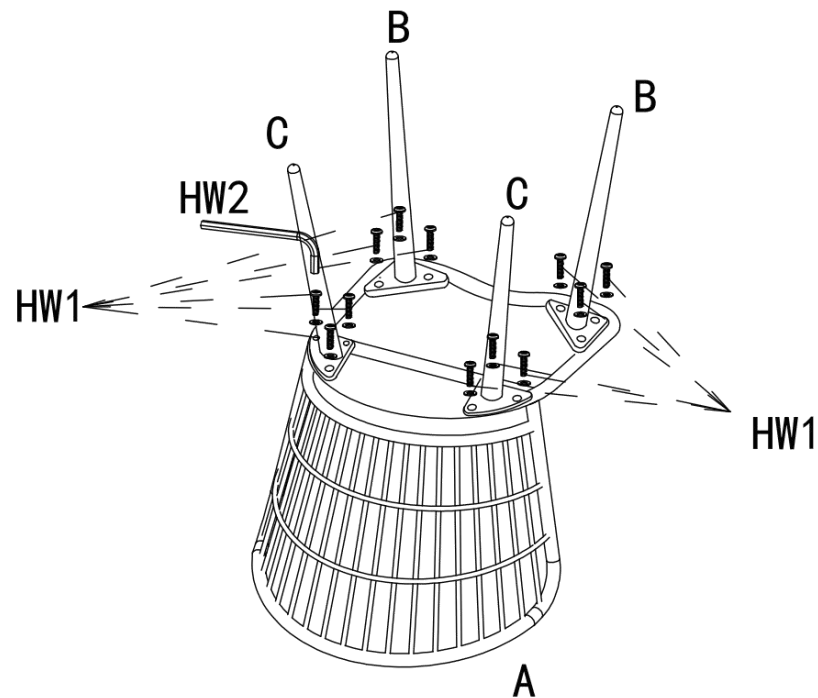

STEP 2

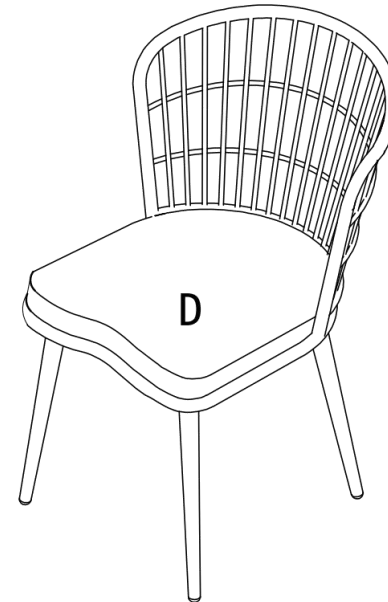

PREPARATION

Before beginning assembly of product, make sure all parts are present. Compare parts with package contents list and hardware contents list. If any part is missing or damaged, do not attempt to assemble the product.

Estimated Assembly Time: 45 minutes.

Tools Required for Assembly (included): Allen Key

Do not fully tighten bolts until assembly is complete.

Table Assemble

STEP 1

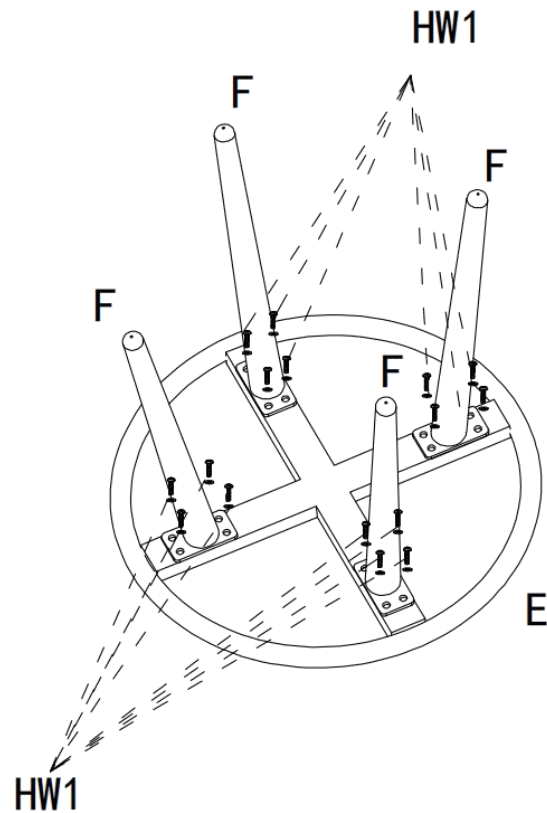

STEP 2

