

CARE AND MAINTENANCE

Store outdoor furniture indoors or cover well when not in use.
 Remove wicker furniture from standing water. Dust regularly with small brush or vacuum
 Spills should be taken care of immediately before they harden or stain with a slightly dampened sponge.











NOTICE

- * Please make sure that you have all parts indicated before you begin assembly of this item
- * This item should be assembled on a soft surface to prevent scratching the finish during assembly
- * This item may require periodic tightening



Weight Capacity : 275 lbs (single seat)
 550 lbs (towperson seat)
 Warning : Do not stand on table/chair/bench
 Warning : Do not over torque bolts/screws

Part List and Hardware List

PIECE	DESCRIPTION	PICTURE	QUANTITY
A	Bench Seat Frame		1X
B	Leg Chair		12X
C	Bench Seat Cushion		1X
D	Chair Seat Frame		2X
E	Chair Seat Cushion		2X
F	Table Frame		1X
I	Leg Table		4X
G	Glass		1X
HW1	Socket Screw 6 x 0.5 x 15 mm		64X
HW2	Flat Washer		64X
HW3	Allen Key		3X



Model# PAT7526

Product Dimensions:

- 25.98" W x 24.01" D x 32.28" H (Chair)
- 55.11" W x 24.01" D x 32.28" H (Bench)
- 35.43" W x 19.68" D x 15.35" H (Table)

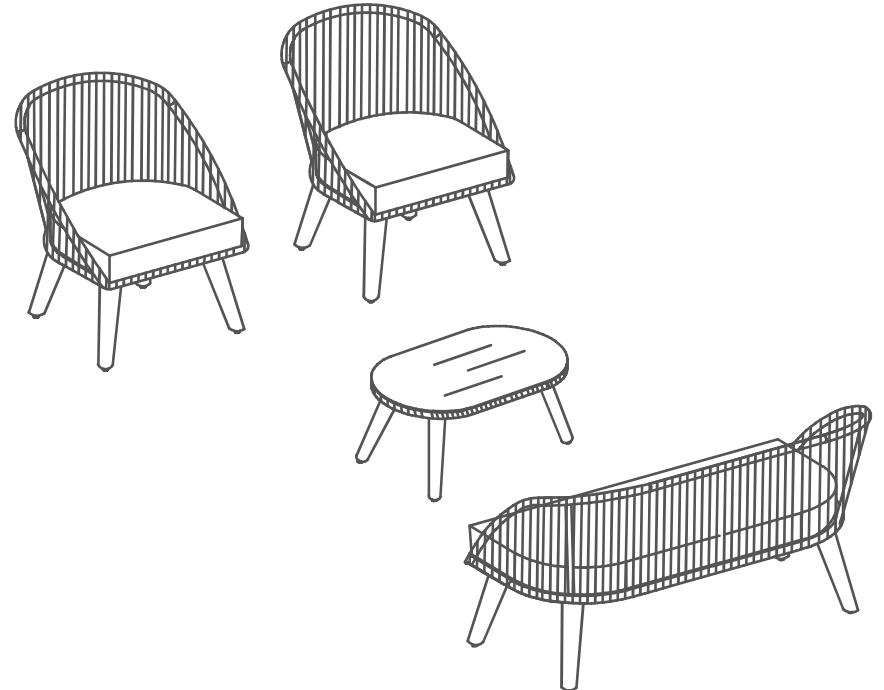







CARE AND MAINTENANCE

Store outdoor furniture indoors or cover well when not in use.
Remove wicker furniture from standing water. Dust regularly with small brush or vacuum
Spills should be taken care of immediately before they harden or stain with a slightly dampened sponge.

NOTICE

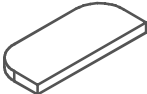
- * Please make sure that you have all parts indicated before you begin assembly of this item
- * This item should be assembled on a soft surface to prevent scratching the finish during assembly
- * This item may require periodic tightening

Part List and Hardware List

PIECE	DESCRIPTION	PICTURE	QUANTITY
A	Bench Seat Frame		1X
B	Leg Chair		4X
C	Bench Seat Cushion		1X
HW1	Socket Screw 6 x 0.5 x 15 mm		16X
HW2	Flat Washer		16X
HW3	Allen Key		1X

 **SAFAVIEH**
O U T D O O R

Weight Capacity : 550 lbs

Warning : Do not stand on Bench

Warning : Do not over torque bolts/screws



Model# PAT7526

Product Dimensions: 55.11" W x 24.01" D x 32.28" H

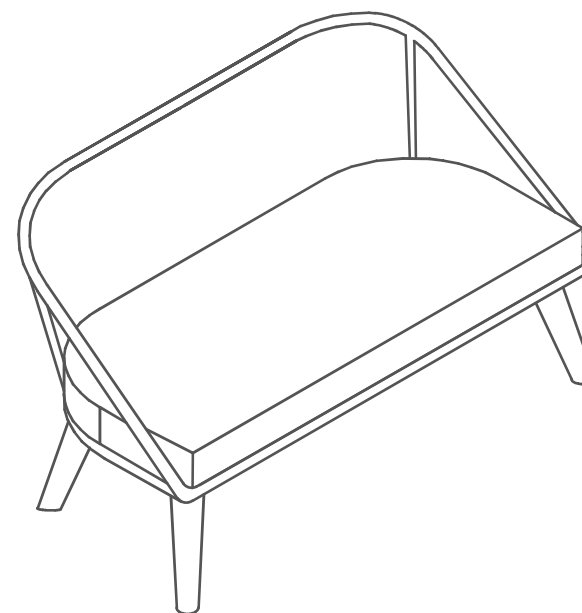

PREPARATION

Before beginning assembly of product, make sure all parts are present. Compare parts with package contents list and hardware contents list.

If any part is missing or damaged, do not attempt to assemble the product.

Estimated Assembly Time: 10 minutes.

Tools Required for Assembly (included): Allen Key

1

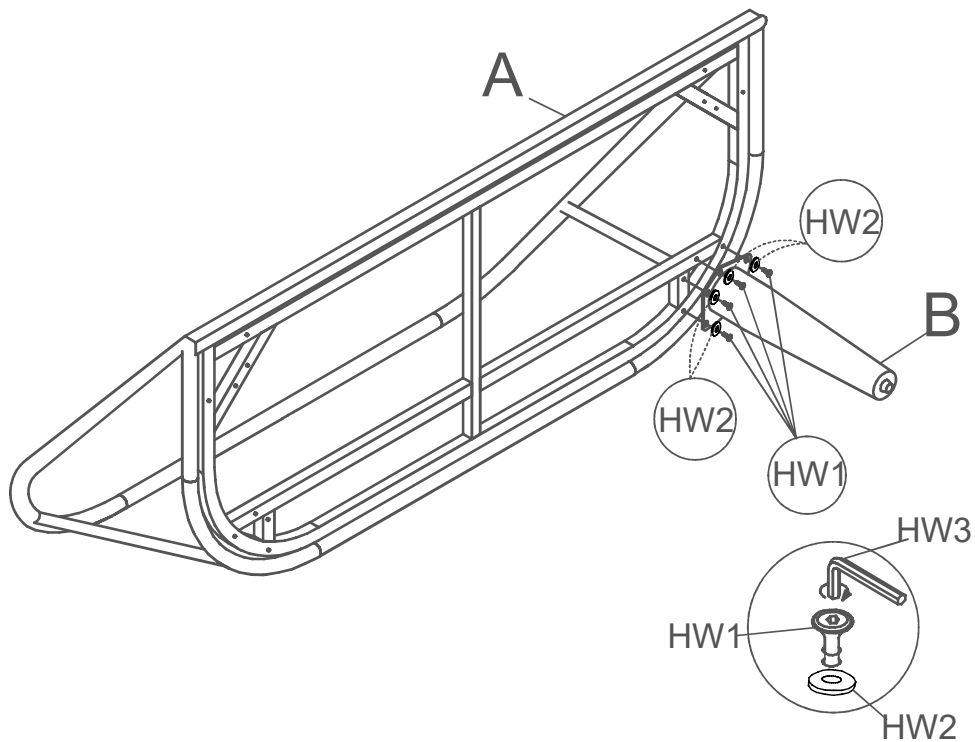

Step 1

Attach Leg Chair (B) to Bench Seat Frame (A). Use Bolt (HW1) tighten with Allen Key (HW3).

2

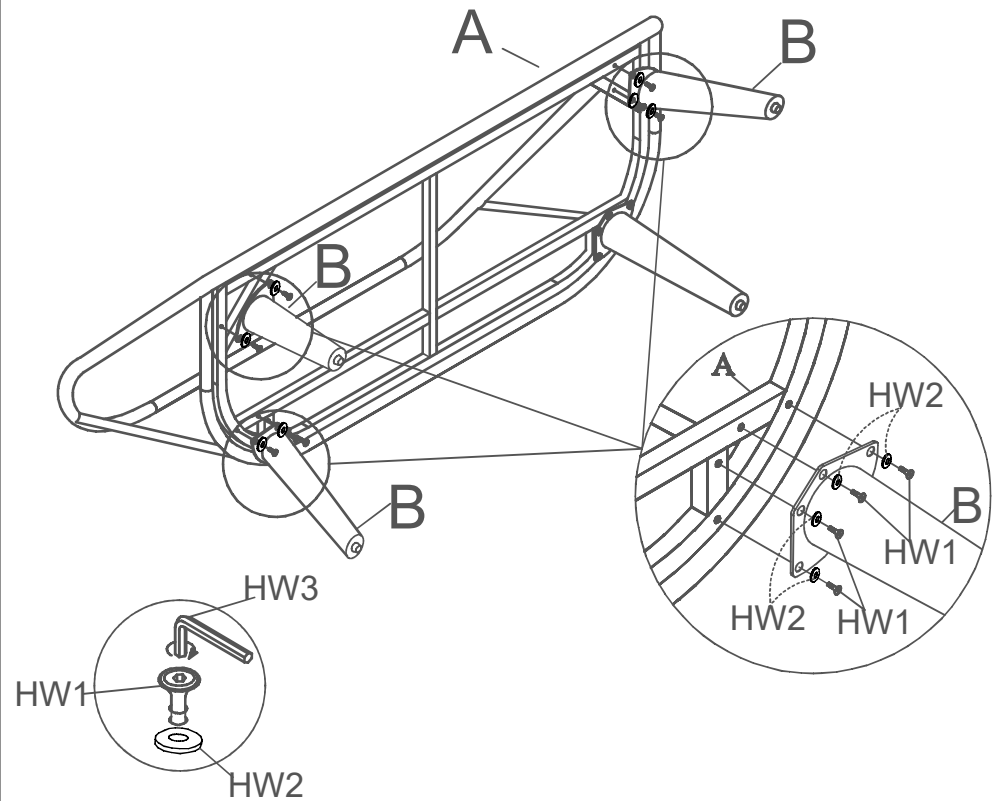

Step 2

Like step 1 using Leg Chair (B) is inserted into the Bench Seat Frame (A). Use Bolt (HW1) tighten with Allen Key (HW3).

PREPARATION

Before beginning assembly of product, make sure all parts are present. Compare parts with package contents list and hardware contents list.

If any part is missing or damaged, do not attempt to assemble the product.

Estimated Assembly Time: 10 minutes.

Tools Required for Assembly (included): Allen Key

3

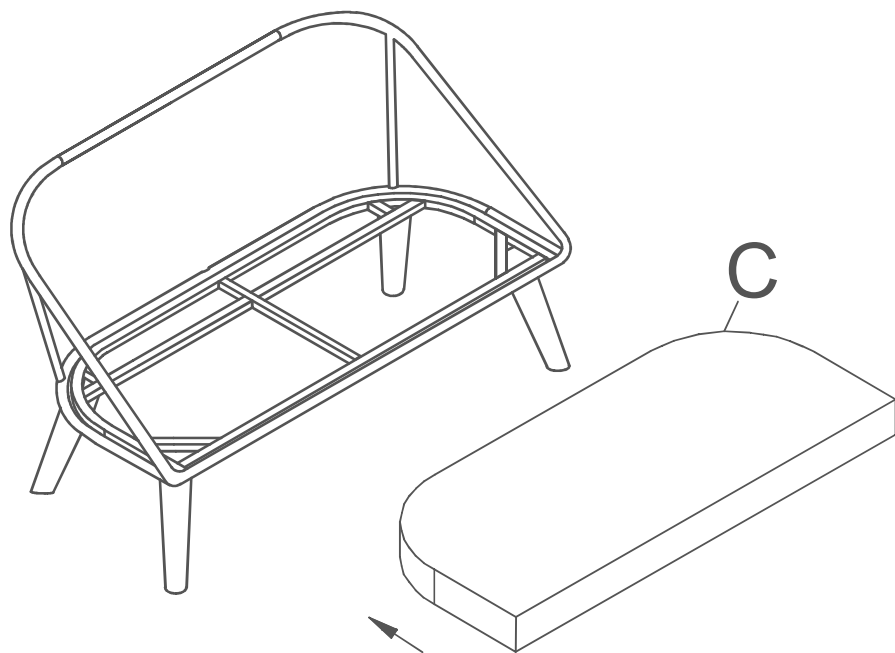

Step 3

Put Bench Seat Cushion (C) on the Bench. The Bench is ready to be used.

4

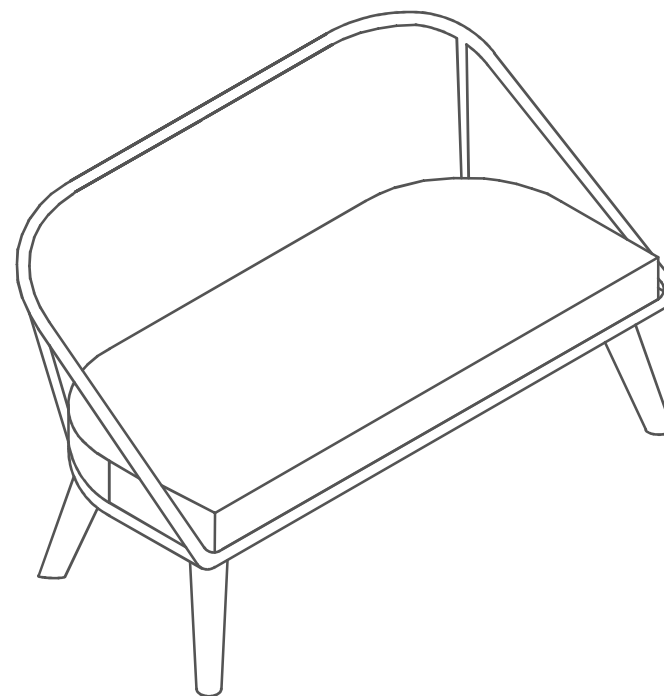

Step 4

Caution: This Bench can only be used on a flat, level surface

CARE AND MAINTENANCE

Store outdoor furniture indoors or cover well when not in use.
Remove wicker furniture from standing water. Dust regularly with small brush or vacuum
Spills should be taken care of immediately before they harden or stain with a slightly dampened sponge.

NOTICE

- * Please make sure that you have all parts indicated before you begin assembly of this item
- * This item should be assembled on a soft surface to prevent scratching the finish during assembly
- * This item may require periodic tightening











 **SAFAVIEH**
O U T D O O R

Weight Capacity : 275 lbs (single seat)
550 lbs (towperson seat)

Warning : Do not stand on table/chair/bench

Warning : Do not over torque bolts/screws

Part List and Hardware List

PIECE	DESCRIPTION	PICTURE	QUANTITY
A	Bench Seat Frame		1X
B	Leg Chair		12X
C	Bench Seat Cushion		1X
D	Chair Seat Frame		2X
E	Chair Seat Cushion		2X
F	Table Frame		1X
I	Leg Table		4X
G	Glass		1X
HW1	Socket Screw 6 x 0.5 x 15 mm		64X
HW2	Flat Washer		64X
HW3	Allen Key		3X



Model# PAT7526

Product Dimensions:

25.98" W x 24.01" D x 32.28" H (Chair)

55.11" W x 24.01" D x 32.28" H (Bench)

35.43" W x 19.68" D x 15.35" H (Table)

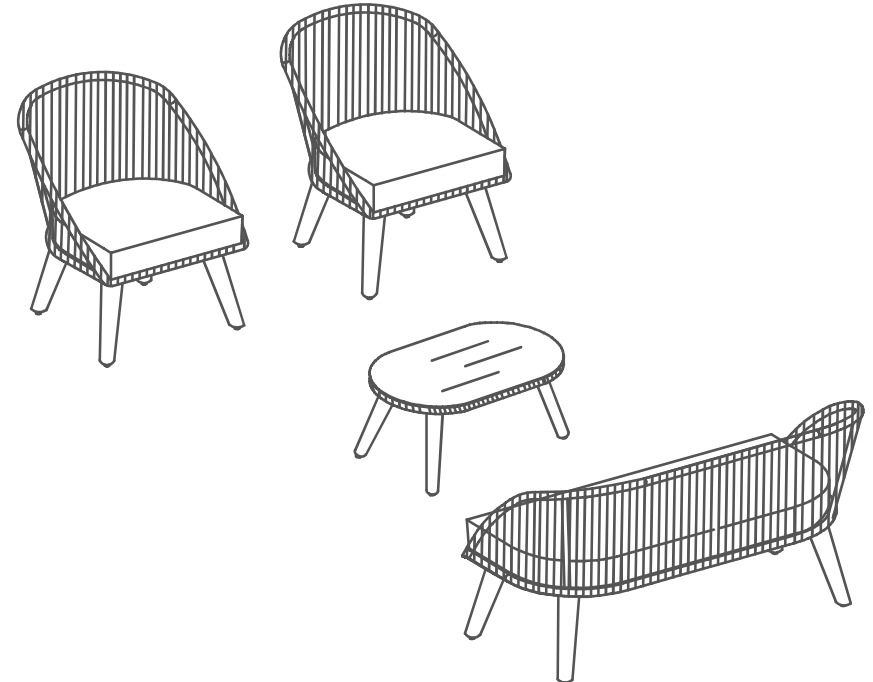





CARE AND MAINTENANCE

Store outdoor furniture indoors or cover well when not in use.
Remove wicker furniture from standing water. Dust regularly with small brush or vacuum
Spills should be taken care of immediately before they harden or stain with a slightly dampened sponge.

NOTICE

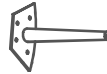
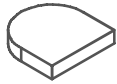
- * Please make sure that you have all parts indicated before you begin assembly of this item
- * This item should be assembled on a soft surface to prevent scratching the finish during assembly
- * This item may require periodic tightening

Part List and Hardware List

PIECE	DESCRIPTION	PICTURE	QUANTITY
D	Chair Seat Frame		2X
B	Leg Chair		8X
E	Chair Seat Cushion		2X
HW1	Socket Screw 6 x 0.5 x 15 mm		32X
HW2	Flat Washer		32X
HW3	Allen Key		1X

 **SAFAVIEH**
O U T D O O R

Weight Capacity : 275 lbs

Warning : Do not stand on Bench

Warning : Do not over torque bolts/screws



! WARNING !



Model# PAT7526

Product Dimensions: 25.98" W x 24.01" D x 32.28" H

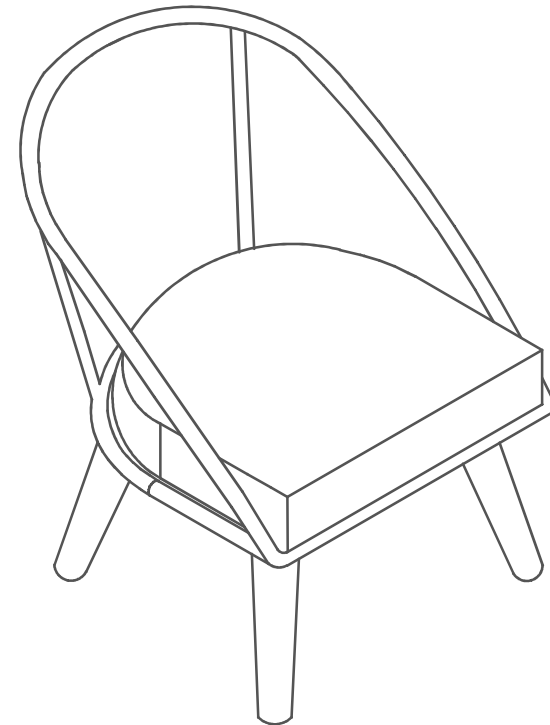

PREPARATION

Before beginning assembly of product, make sure all parts are present. Compare parts with package contents list and hardware contents list.

If any part is missing or damaged, do not attempt to assemble the product.

Estimated Assembly Time: 10 minutes.

Tools Required for Assembly (included): Allen Key

1

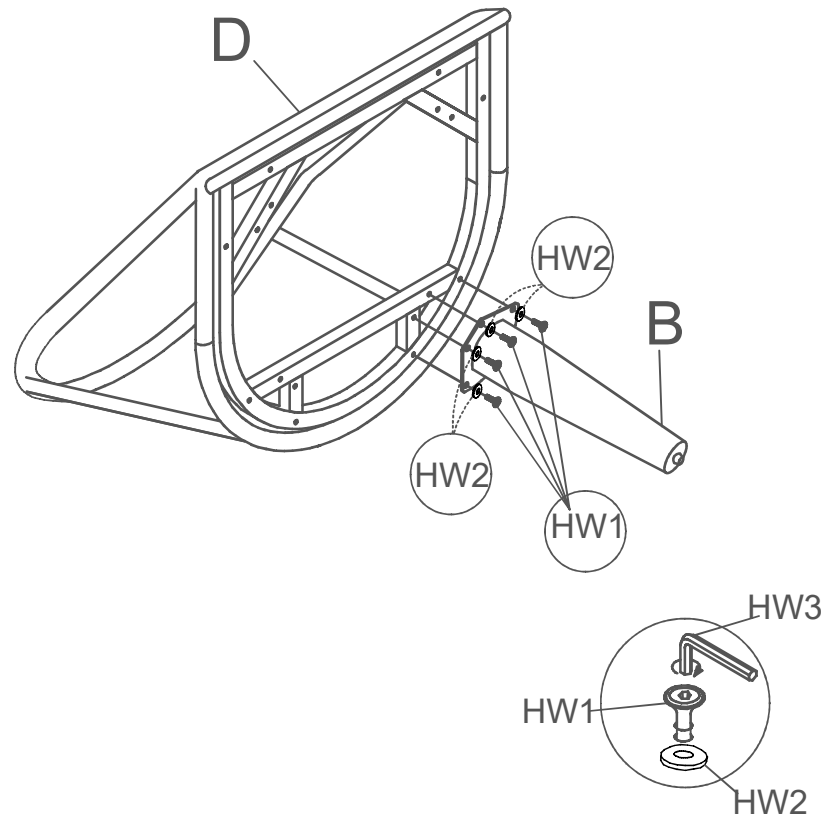

Step 1
Attach Leg Chair (B) to Chair Seat Frame (D). Use Bolt (HW1) tighten with Allen Key (HW3).

2

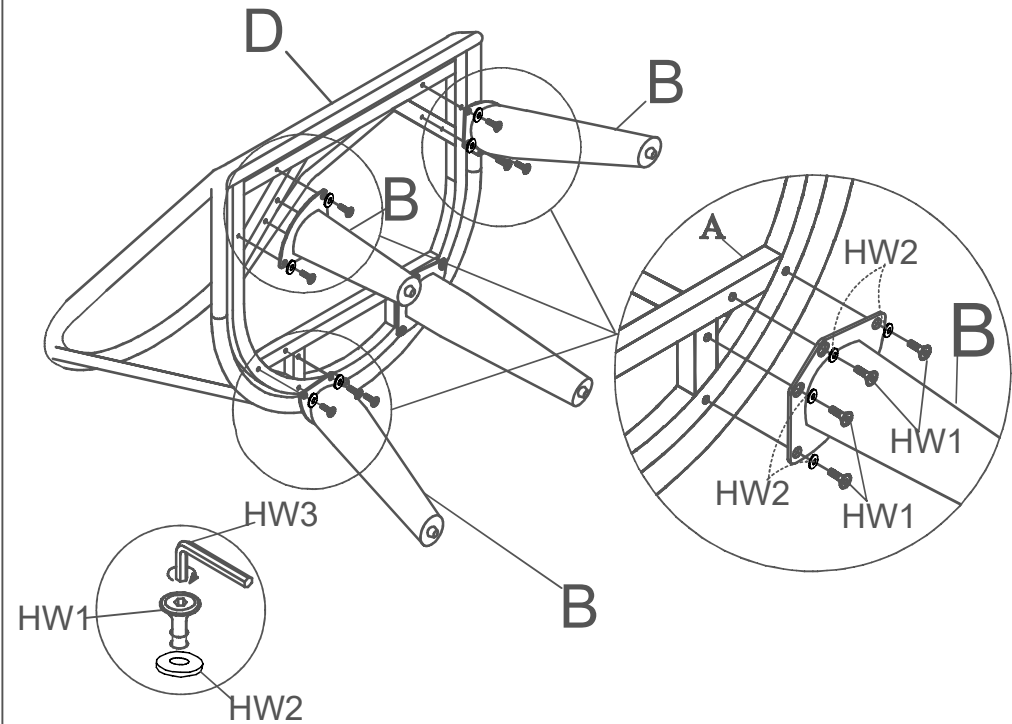

Step 2
Like step 1 using Leg Chair (B) is inserted into the Chair Seat Frame (D). Use Bolt (HW1) tighten with Allen Key (HW3).

PREPARATION

Before beginning assembly of product, make sure all parts are present. Compare parts with package contents list and hardware contents list.

If any part is missing or damaged, do not attempt to assemble the product.

Estimated Assembly Time: 10 minutes.

Tools Required for Assembly (included): Allen Key

3

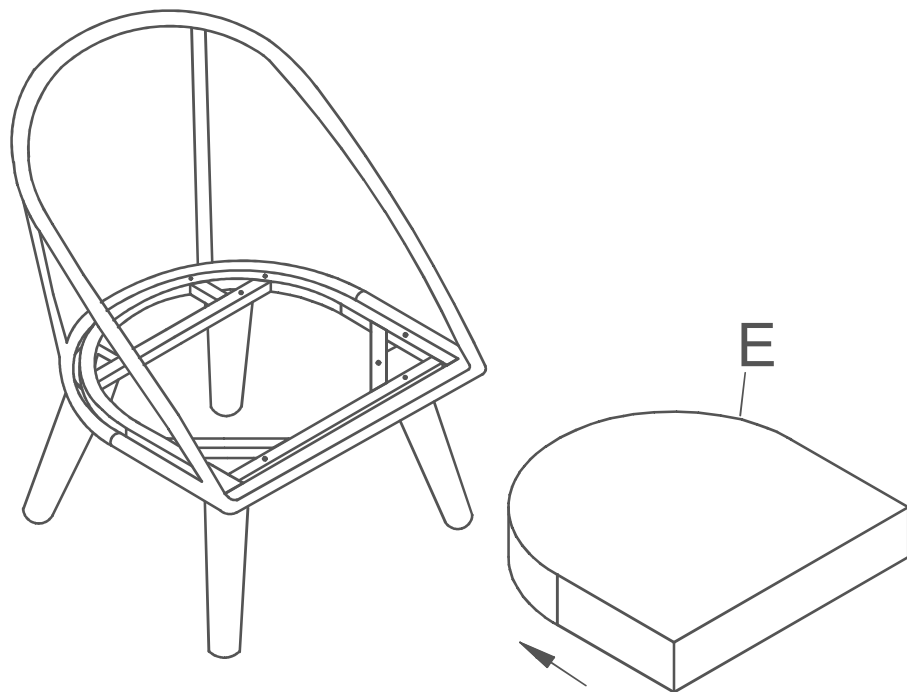

Step 3

Put Chair Seat Cushion (E) on the Chair. The Chair is ready to be used.

4

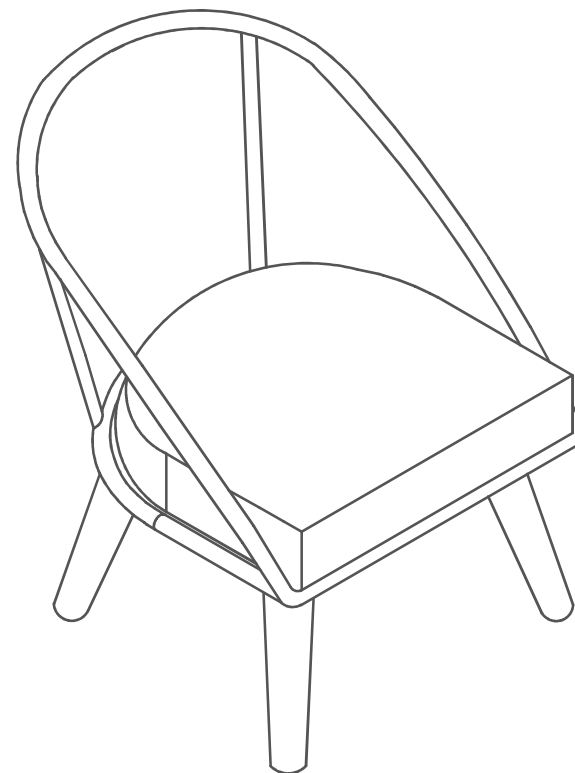

Step 4

Caution: This Chair can only be used on a flat, level surface

CARE AND MAINTENANCE

Store outdoor furniture indoors or cover well when not in use.
Remove wicker furniture from standing water. Dust regularly with small brush or vacuum
Spills should be taken care of immediately before they harden or stain with a slightly dampened sponge.











NOTICE

- * Please make sure that you have all parts indicated before you begin assembly of this item
- * This item should be assembled on a soft surface to prevent scratching the finish during assembly
- * This item may require periodic tightening



Weight Capacity : 275 lbs (single seat)
550 lbs (towperson seat)
Warning : Do not stand on table/chair/bench
Warning : Do not over torque bolts/screws

Part List and Hardware List

PIECE	DESCRIPTION	PICTURE	QUANTITY
A	Bench Seat Frame		1X
B	Leg Chair		12X
C	Bench Seat Cushion		1X
D	Chair Seat Frame		2X
E	Chair Seat Cushion		2X
F	Table Frame		1X
I	Leg Table		4X
G	Glass		1X
HW1	Socket Screw 6 x 0.5 x 15 mm		64X
HW2	Flat Washer		64X
HW3	Allen Key		3X



Model# PAT7526

Product Dimensions:

25.98" W x 24.01" D x 32.28" H (Chair)
55.11" W x 24.01" D x 32.28" H (Bench)
35.43" W x 19.68" D x 15.35" H (Table)

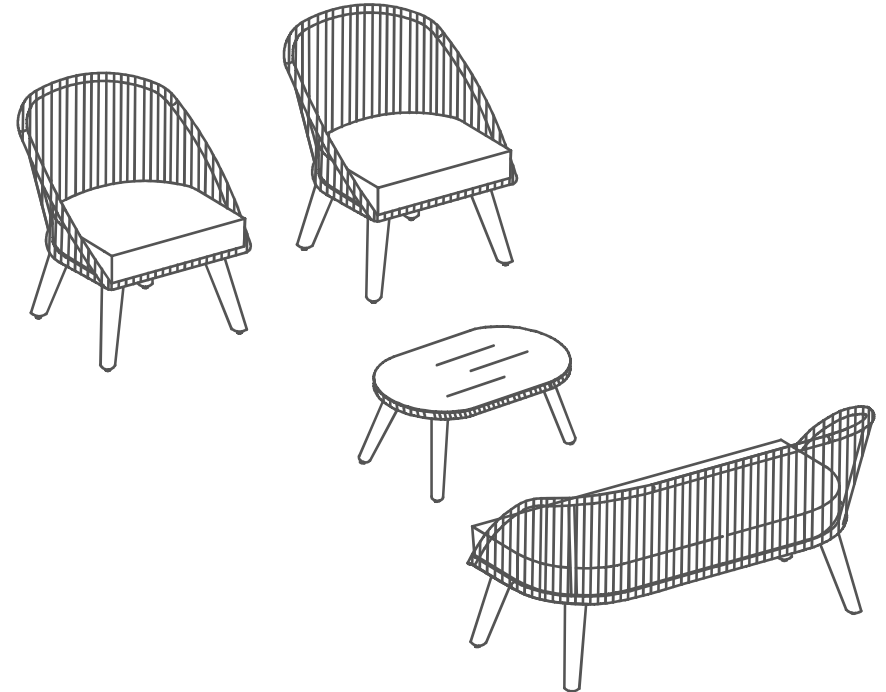







CARE AND MAINTENANCE

Store outdoor furniture indoors or cover well when not in use.
Remove wicker furniture from standing water. Dust regularly with small brush or vacuum
Spills should be taken care of immediately before they harden or stain with a slightly dampened sponge.

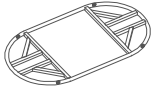
NOTICE

- * Please make sure that you have all parts indicated before you begin assembly of this item
- * This item should be assembled on a soft surface to prevent scratching the finish during assembly
- * This item may require periodic tightening

Part List and Hardware List

PIECE	DESCRIPTION	PICTURE	QUANTITY
F	Table Frame		1X
I	Leg Table		4X
G	Glass		1X
HW1	Socket Screw 6 x 0.5 x 15 mm		16X
HW2	Flat Washer		16X
HW3	Allen Key		1X

 **SAFAVIEH**
O U T D O O R

Weight Capacity : 40 lbs

Warning : Do not stand on Bench

Warning : Do not over torque bolts/screws



Model# PAT7526

Product Dimensions: 35.43" W x 19.68" D x 15.35" H

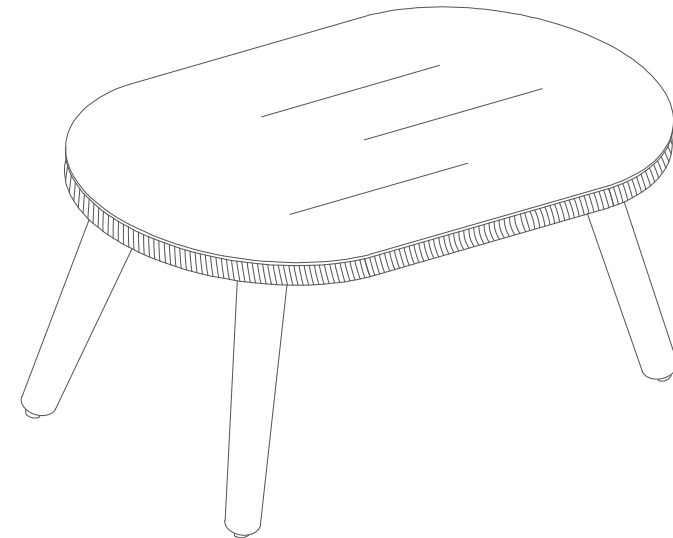

PREPARATION

Before beginning assembly of product, make sure all parts are present. Compare parts with package contents list and hardware contents list.

If any part is missing or damaged, do not attempt to assemble the product.

Estimated Assembly Time: 10 minutes.

Tools Required for Assembly (included): Allen Key

1

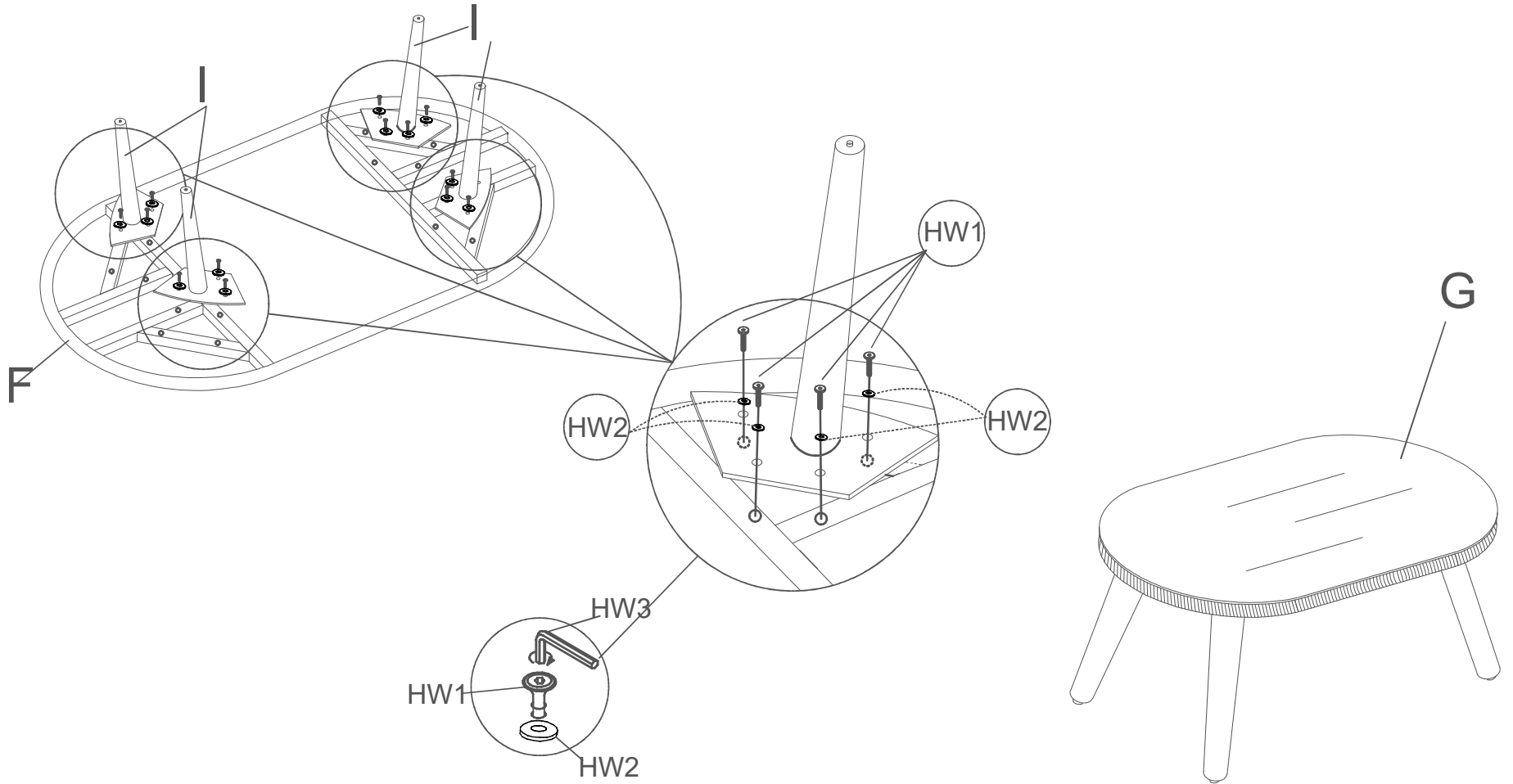

Step 1

Attach Leg Table (I) to Table Frame (F). Use Bolt (HW1) tighten with Allen Key (HW3). Put a Glass (G) on table to finish.

Caution : This Table can only be used on a flat, level surface.