

CARE AND MAINTENANCE

Store outdoor furniture indoors or cover well when not in use.

Remove wooden furniture from standing water. Dust regularly with small brush or vacuum

Spills should be taken care of immediately before they harden or stain with a slightly dampened sponge.

NOTICE











* Please make sure that you have all parts indicated before you begin assembly of this item

* This item should be assembled on a soft surface to prevent scratching the finish during assembly

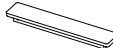
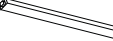
* This item may require periodic tightening

 **SAFAVIEH**
O U T D O O R

Part List and Hardware List

PIECE	DESCRIPTION	PICTURE	QUANTITY
A	Back Frame		1X
B	Seat frame		1X
C	Front leg		2X
D	Back leg		2X
E	Base plate		2X
H1	Armrest		2X
H2	Cross bar of leg		2X
H3	Allen bolt L	 8x40mm	18X
H4	Screw -1	 7x50mm	6X
H5	Screw -2	 7x70mm	2X
H6	Screw -3	 4x45mm	2X
H7	Allen key		1X
H8	Allen key		1X

Model# PAT7023C

Product Dimensions: 28.35" W x 24.80" D x 37.40" H

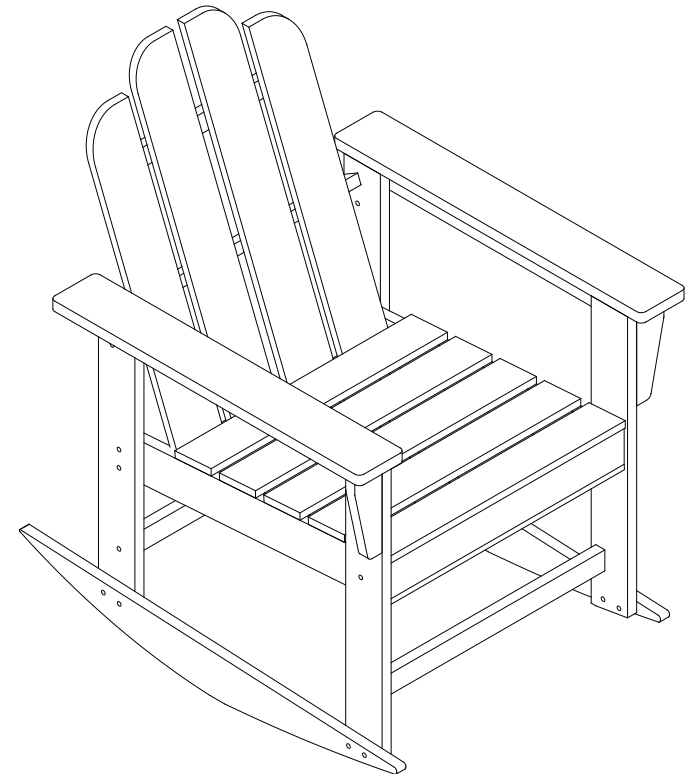

PREPARATION

Before beginning assembly of product, make sure all parts are present. Compare parts with package contents list and hardware contents list. If any part is missing or damaged, do not attempt to assemble the product.

Estimated Assembly Time: 30 minutes.

Tools Required for Assembly (included): Allen Key

1

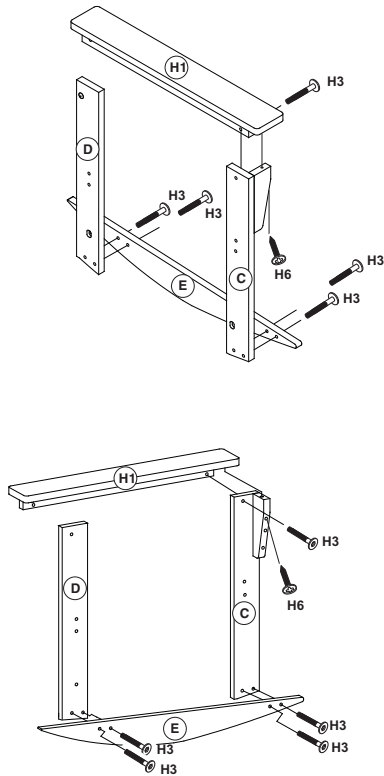

Step 1

Attached (H1) & (B) to (D) & (C), using (H3), (H4) tighten with (H7)

2

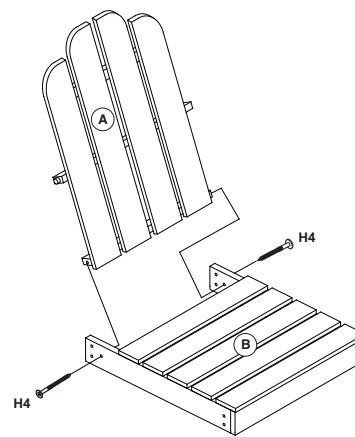

Step 2

Attached (A) to frame (B) using (H4) tighten with H8

3

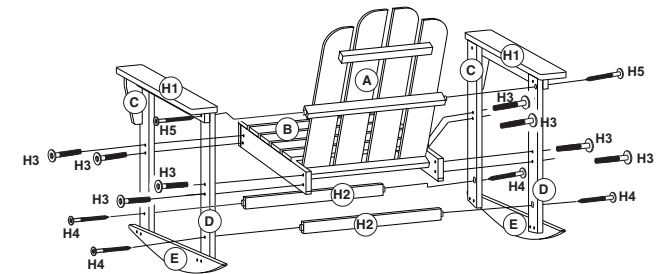

Step 3

Attached (E), (H1), (D), (C) to (A), (B), (H2), then using (H3), (H4), (H5) tighten with (H7), (H8)