









PRE AND MAINTENANCE

Do not clean using a mild water-free solvent. Only a professional cleaner should undertake a complete overall cleaning.
The use of steam or water-based cleaners may cause excessive shrinking or staining.

NOTICE

Please make sure that you have all parts indicated before you begin assembly of this item.
This item should be assembled on a soft surface to prevent scratching the finish.
This item may require periodic tightening.

Part List and Hardware List

ITEM	DESCRIPTION	QUANTITY	PICTURE	QUANTITY
A	SEAT	1X		1X
B	Front leg-1	1X		1X
C	Front leg-2	1X		1X
D	Back leg-1	1X		1X
E	Back leg-2	1X		1X
H1	Allen bolt L	8X		8X
H2	Spring washer	8X		8X
H3	Flat washer	8X		8X
H4	Allen key	1X		1X

SAFAVIEH FURNITURE

Model# MCR4709

Product Dimensions: 22.04" W x 24.80" D x 36.42" H

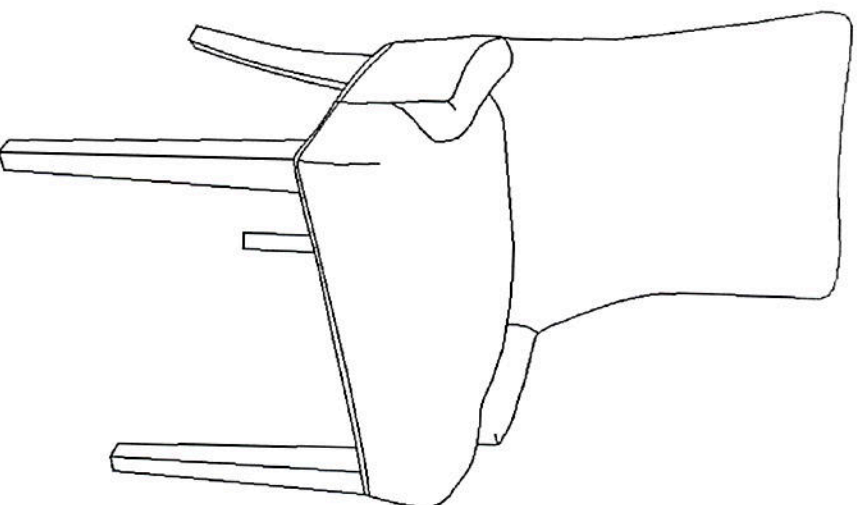

PREPARATION

Before beginning assembly of product, make sure all parts are present. Compare parts with package contents list and hardware contents list. If any part is missing or damaged, do not attempt to assemble the product.

Estimated Assembly Time: 10 minutes.

Tools Required for Assembly (included): Allen Key

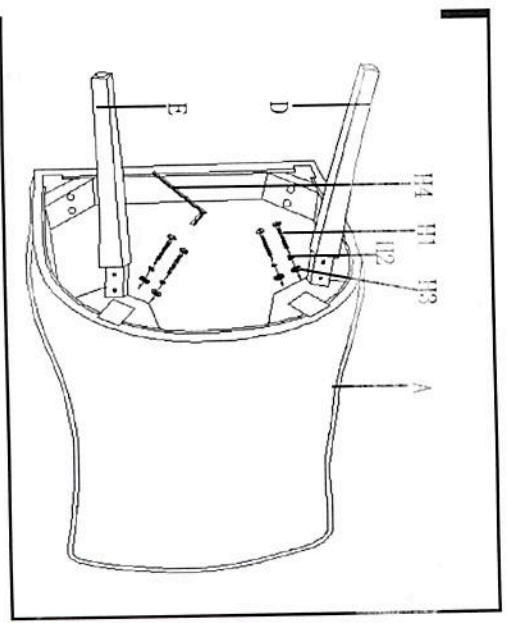
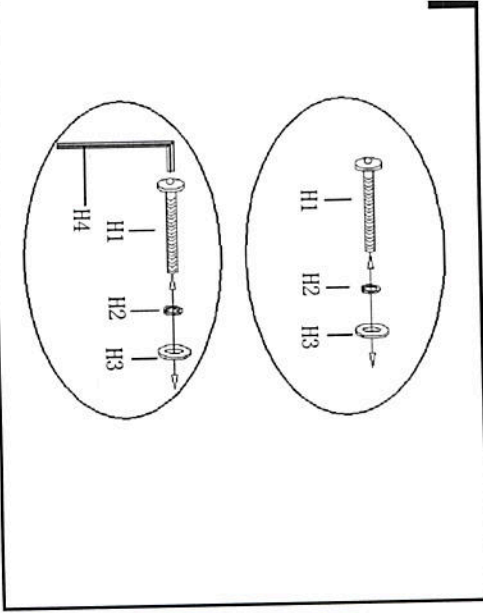

2

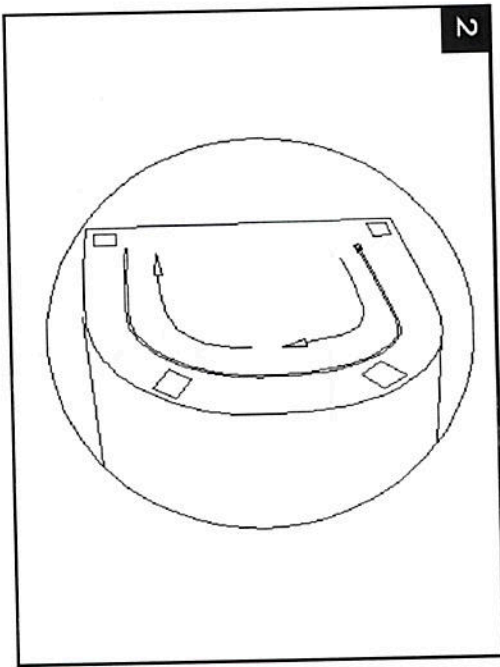

5

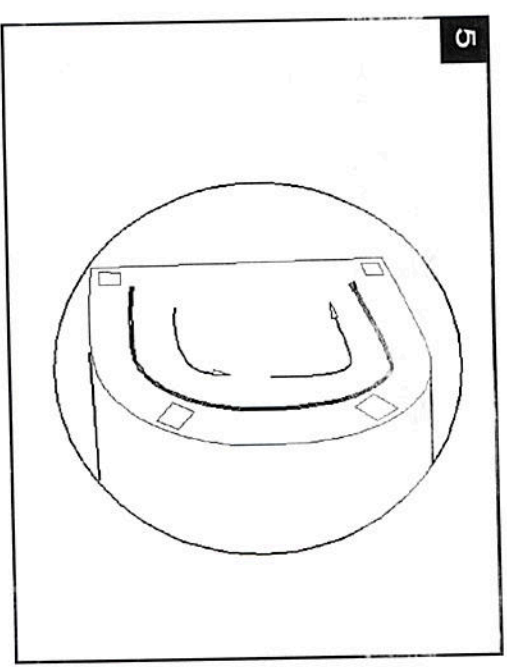

3

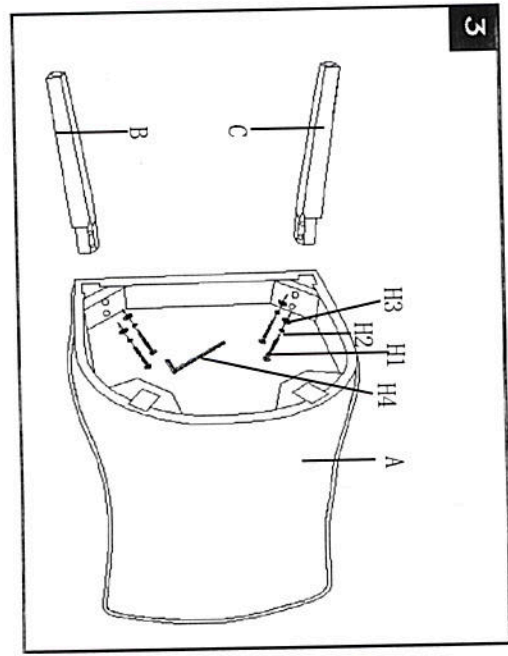

6

