

SAFAVIEH LIGHTING

Assembly Instruction

CAUTION: Read instruction carefully and turn electricity off at main circuit breaker panel before beginning installation.

ITEM #:LIT4441A

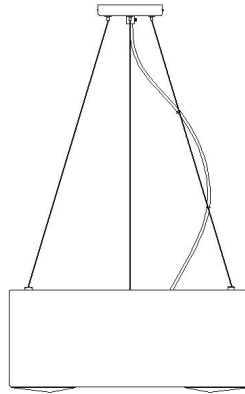

Care and Cleaning









To clean the outside of the fixture, use a dry or slightly dampened clean cloth (use clean water, never a solvent) to wipe the surface of the fixture.

To clean the inside of the fixture, first disconnect power to the fixture by turning off the circuit breaker or by removing the fuse at the fuse box. Next, use a dry or slightly dampened clean cloth (use clean water, never a solvent) to wipe the interior surface of the fixture.

Do not use any cleaners with chemical, solvents or harsh abrasives. Use Only a dry soft cloth to dust or wipe carefully.

Estimated Assembly Time: 30 minutes

Part List and Hardware List

PIECE	DESCRIPTION	PICTURE	QUANTITY	PIECE	DESCRIPTION	PICTURE	QUANTITY
A	Mounting bar		1X	C	Bulb Cover		3X
A1	Mounting screw		2X	D	Plastic screw		1X
A2	Canopy screw		2X	E	Wire Nut		3X
B	Bulb		3X	F	Canopy		1X

Installation

Step 1

Unpack all parts from cartons carefully
 Press lifter to adjust electrical wire to suitable length or twist plastic screw(D) if needing
 Place bulb(B) to the socket and then bulb cover(C)

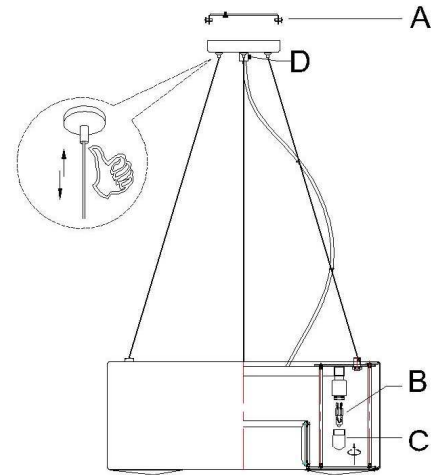

Step 2 Wire Connection

Connect,Hot,Black or Red outlet Supply Wire to:	Connect,Neutral,White Outlet Supply Wire to:
Black	White
* Parallel Cord(round & smooth)	* Parallel Cord(square& ridged)
Clear,Brown,Gold or Black without Tracer(colored stripes)	Clear,Brown,Gold or Black without Tracer(colored stripes)
Insulated Wire(not green) with copper metal conductor	Insulated Wire(not green) with Silver metal conductor



*Note: When parallel wire(SPT I & SPT II) is used.The neutral wire is square shaped and ridged and the hot wire will be round in shape and smooth.(See illustration on left.)

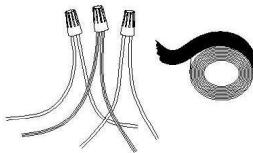

Step 3

Adjust the wire to suitable length before installing the mounting bar(A) with mounting screw(A1),and secure the canopy with canopy screw(A2) by screwdriver

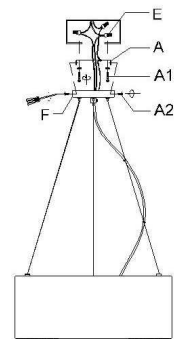

Step 4

Consult a qualified electrician to ensure correct branch circuit conductor

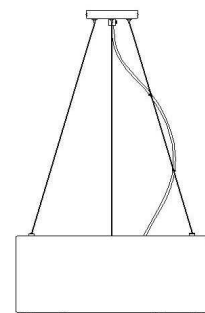

ENJOY YOUR LAMP