

# SAFAVIEH LIGHTING

## Assembly Instruction

**CAUTION:** Read instruction carefully and turn electricity off at main circuit breaker panel before beginning installation.

ITEM #:LIT44 32A

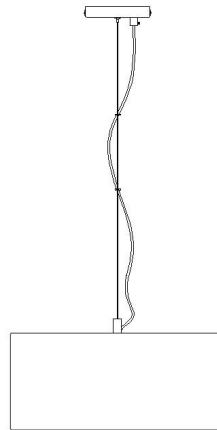

### Care and Cleaning











To clean the outside of the fixture, use a dry or slightly dampened clean cloth (use clean water, never a solvent) to wipe the surface of the fixture.

To clean the inside of the fixture, first disconnect power to the fixture by turning off the circuit breaker or by removing the fuse at the fuse box. Next, use a dry or slightly dampened clean cloth (use clean water, never a solvent) to wipe the interior surface of the fixture.

Do not use any cleaners with chemical, solvents or harsh abrasives. Use Only a dry soft cloth to dust or wipe carefully.

Estimated Assembly Time: 30 minutes

### Part List and Hardware List

PIECE	DESCRIPTION	PICTURE	QUANTITY	PIECE	DESCRIPTION	PICTURE	QUANTITY
A	Mounting bar		1X	E	Acrylic diffuser		1X
A1	Mounting screw		2X				
B	Bulb		3X	F	Metal round plate & nipple		1X
C	Metal round plate		1X	G	Metal tube		1X
				H	Plastic screw		1X
D	Canopy screw		2X	I	Wire nut		3X
				J	Canopy		1X

# Installation

## Step 1

Unpack all parts from cartons carefully

Press cable lifter and twist plastic screw(H) to adjust electrical wire to suitable length before screw the metal tube(G)

Place the bulb(B) to the socket

Place the metal round plate(C), acrylic diffuser(E) to the nipple of the lamp body, then tighten with metal round plate & nipple(F)

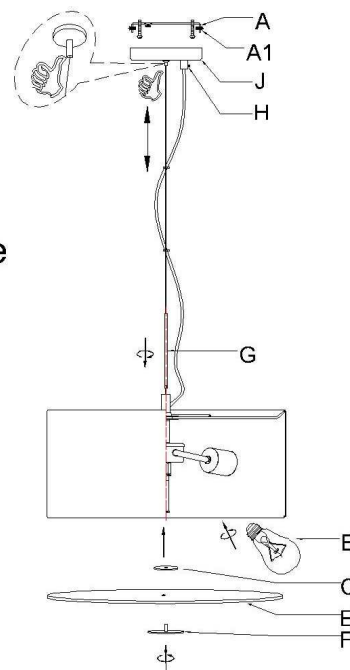

## Step 2 Wire Connection

Connect, Hot, Black or Red outlet Supply Wire to:	Connect, Neutral, White Outlet Supply Wire to:
Black	White
* Parallel Cord (round & smooth)	* Parallel Cord (square & ridged)
Clear, Brown, Gold or Black without Tracer (colored stripes)	Clear, Brown, Gold or Black without Tracer (colored stripes)
Insulated Wire (not green) with copper metal conductor	Insulated Wire (not green) with Silver metal conductor

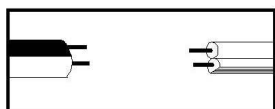

\*Note: When parallel wire (SPT I & SPT II) is used, the neutral wire is square shaped and ridged and the hot wire will be round in shape and smooth. (See illustration on left.)

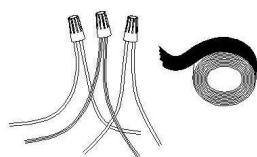

## Step 3

Installing the mounting bar (A) with mounting screw (A1) to canopy with canopy screw (D) by screwdriver.

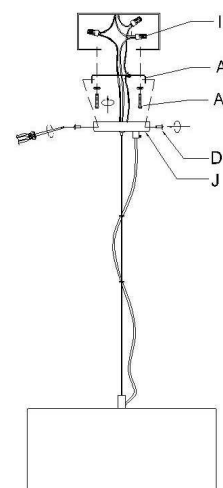

## Step 4

Consult a qualified electrician to ensure correct branch circuit conductor

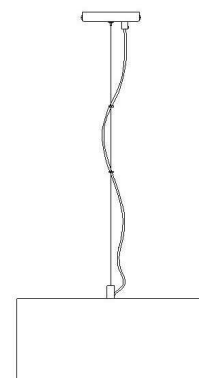

ENJOY YOUR LAMP