



SAFAVIEH

LIGHTING

Assembly Instruction

CAUTION Read instruction carefully and turn electricity off at main circuit breaker panel before beginning installation.

ITEM#:LIT4411 A/B/C

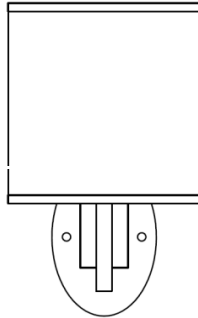

Care and Cleaning









To clean the outside of the fixture, use a dry or slightly dampened clean cloth(use clean water, never a solvent)to wipe the surface of the fixture.

To clear the inside of the fixture, first disconnect power to the fixture by turning off the circuit breaker or by removing the fuse at the fuse box. Next, use a dry or slightly dampened clean cloth(use clean water, never a solvent) to wipe the interior surface of the fixture

Do not use any cleaners with chemical, solvents or harsh abrasives. Use Only a dry soft cloth to dust or wipe carefully.

Estimated Assembly Time:30 minutes

Part List and Hardware List

PIECE	DESCRIPTION	PICTURE	QUANTITY	PIECE	DESCRIPTION	PICTURE	QUANTITY
A	Mounting bar		1X	D	Shade		1X
A1	Mounting screw		2X	E	Socket Ring		1X
B	Lampbody		1X	F	screwed ball		2X
C	Bulb		1X	G	Bracket screw		2X

Installation

Step 1

Unpack all parts from cartons carefully
 Screw the bracket screw(G) on the mounting bar(A)
 Installing the mounting bar(A) with screws(A1) to the outlet box

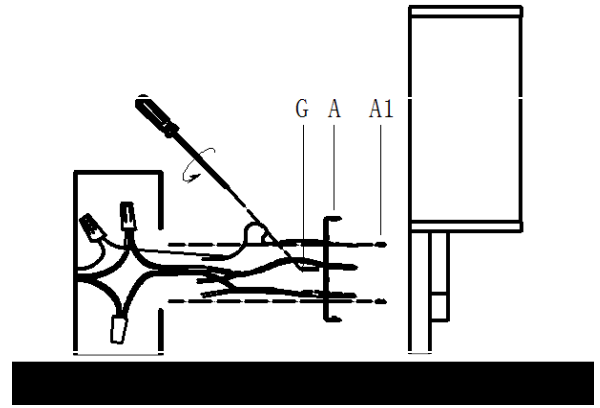

Step 2 Wire connection

Connect, Hot, Black or Red outlet Supply Wire to:	Connect, Neutral, White Outlet Supply Wire to:
Black	White
*Parallel Cord(round&smooth)	*Parallel Cord(square&ridged)
Clear, Brown, Gold or Black without Tracer(colored stripes)	Clear, Brwn, Gold or Black without Tracer(colored stripes)
Insulated Wire(not green)with copper metal conductor	Insulated Wire(not green)with Silver metal conductor

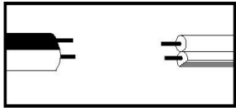

*Note: When parallel wire(SPTI&SPTII)is used. The neutral wire is square shaped and ridged and the hot wire will be round in shape and smooth.(See illustration on left)

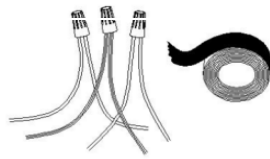

Step 3

Orient the wall canopy so that the bracket screws (G) protruding from the mounting bracket go into the holes of the canopy, then secure it with the provided screwed balls (F). Place the shade (D) on the lamp holder, and secure it with socket ring (E) Install bulbs (C).

PLEASE USE TYPE "B" BULB MAX 40-WATT OR CFL BULB MAX 13-WATT OR LED MAX 9-WATT THERE ARE 1 X 4W LED BULB IN THE BOX.

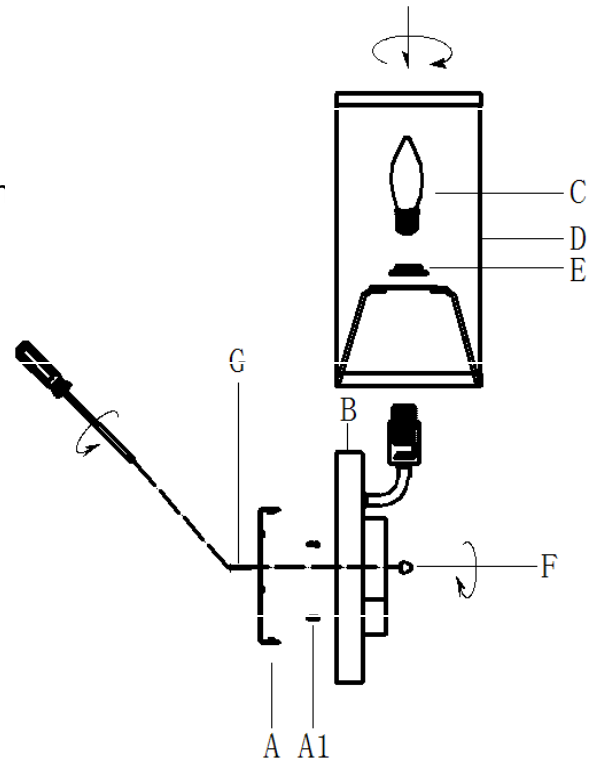

Step 4

Consult a qualified electrician to ensure correct branch circuit conductor

ENJOY YOUR LAMP