

CARE AND MAINTENANCE

Unplug lamps before using any cleaning solutions. Dust shades with a feather duster or with an appropriate vacuum-brush attachment. Wipe with a soft, dry cloth and clean lamp bases with the methods appropriate to the material. Avoid the use of chemicals and household cleaners as they may damage the finish.

NOTICE & IMPORTANT SAFETY INSTRUCTIONS

- * Please make sure that you have all parts indicated before you begin assembly of this item
- * This item should be assembled on a soft surface to prevent scratching the finish during assembly
- * The external flexible cable or cord of this luminaire cannot be replaced,
- * If the cord is damaged, the luminaire shall be destroyed

**This portable lamp has a polarized plug (one blade is wider than the other) as a safety feature to reduce the risk of electric shock. this plug will fit in a polarized outlet only one way. if the plug does not fit fully in the outlet, reverse the plug, if it still does not fit, contact a qualified electrician. Never use with an extension cord unless the plug can be fully inserted. do not attempt to defeat this safety feature.







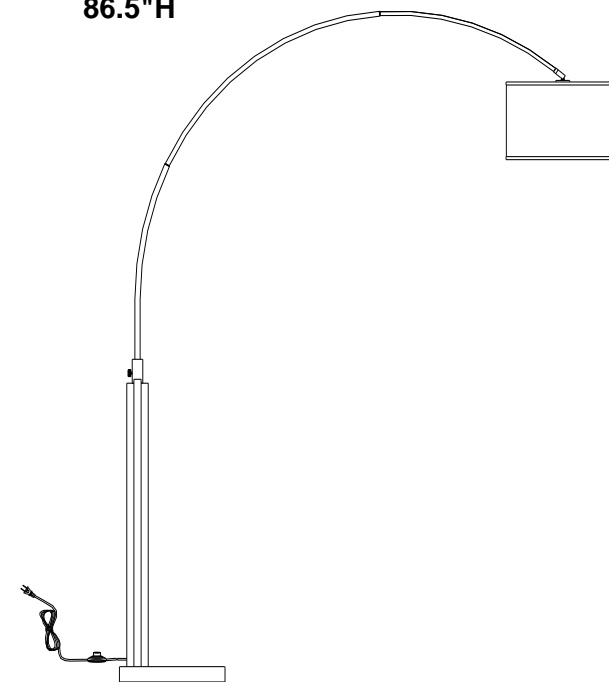







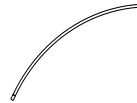

SAFAVIEH
LIGHTING

Model#: LIT4354A

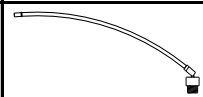
Product Dimensions: 70.75" LX 16"W X 86.5"H



Part List and Hardware List

PIECE	DESCRIPTION	PICTURE	QUANTITY	PIECE	DESCRIPTION	PICTURE	QUANTITY				QUANTITY
A	Lamp body		X1	G	Socket Ring		X1				
B	Tube		X1	H	Bulb		X1				
C	Tube		X1	I	Diffuser		X1	M	Mat		X1
D	Screw		X2	J	Finial		X3	N	washer		X1
E	Tube		X1	K	Wrench key		X1	O	Screw		X1
F	Shade		X1	L	Lamp base		X1	P	Wrench key		X1

PREPARATION

Before beginning assembly of product, make sure all parts are present. Compare parts with package contents list and hardware contents list. If any part is missing or damaged, do not attempt to assemble the product.
Estimated Assembly Time: 20 minutes.

Carefully remove all lamp parts from the box, lay all parts on a flat surface. please see list of items included in box below.

1. Insert lamp body (A) into lamp base(N), then secure by sliding in mat(N), washer(M), screw(O) using wrench key(P)

Stand the now assembled base onto a flat surface.

2. Insert tube(B) to lamp body(A) tightly

3. Insert tube(C) into tube(B) and secure with screws(D) using wrench key(K).

4 .Insert tube(E) into tube(C) and secure with screws(D).

5. Put shade(F) to socket, secure shade with lock ring(G)

6. ,insert bulb(H) (NOT INCLUDED) into socket

7. Attach diffuser(I) to shade(F) securing it with finials(J)

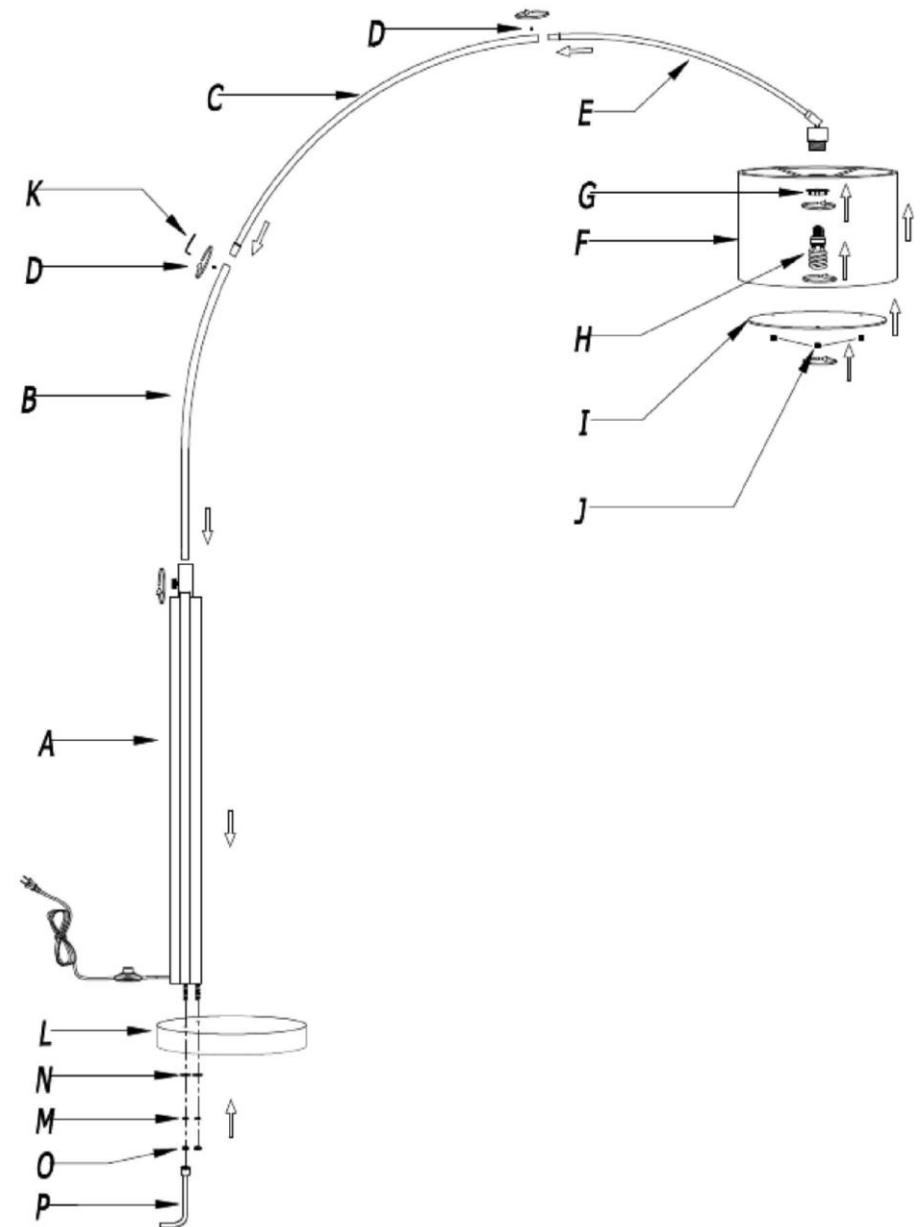

ENJOY YOUR LAMP