

CARE AND MAINTENANCE

Spot clean using a mild water-free solvent. Only a professional cleaner should undertake a complete overall cleaning.

The use of steam or water-based cleaners may cause excessive shrinking or staining.

NOTICE







- * Please make sure that you have all parts indicated before you begin assembly of this item
- * This item should be assembled on a soft surface to prevent scratching the finish during assembly
- * This item may require periodic tightening



Model# FOX6023

Product Dimensions: 18.9" W x 18.9" D x 17.7" H

Part List and Hardware List

PIECE	DESCRIPTION	PICTURE	QUANTITY
1	Marble Top		1X
2	Leg		2X
3	Upper Rail		2X
4	Down Rail		2X
A	Screw (M6x12mm)		20X
B	Allen key		1X

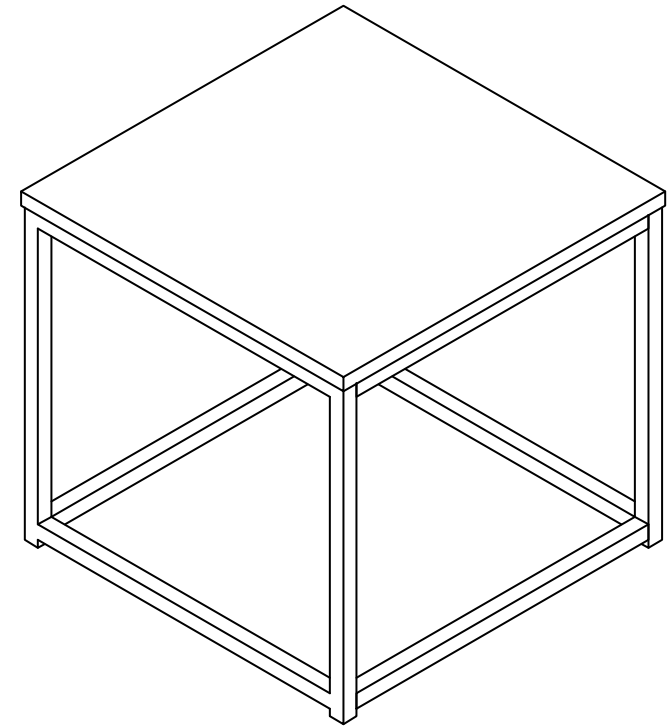

PREPARATION

Before beginning assembly of product, make sure all parts are present. Compare parts with package contents list and hardware contents list.

If any part is missing or damaged, do not attempt to assemble the product.

Estimated Assembly Time: 30minutes.

Tools Required for Assembly : Allen Key

1

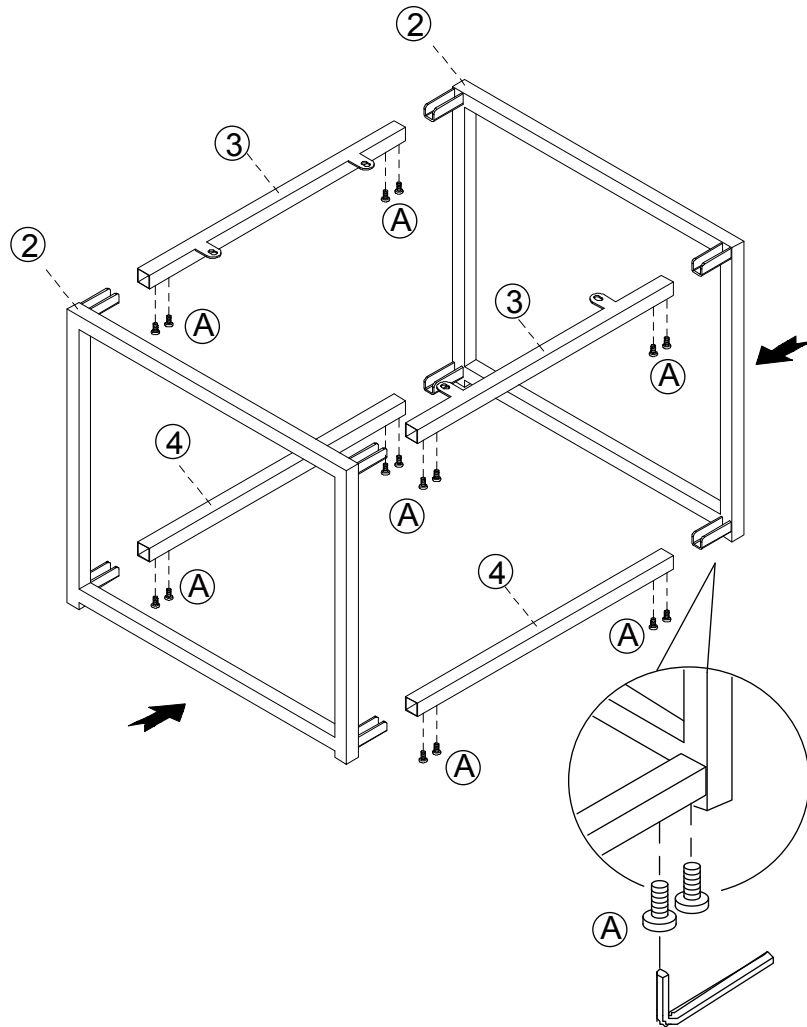

(A) x16



2

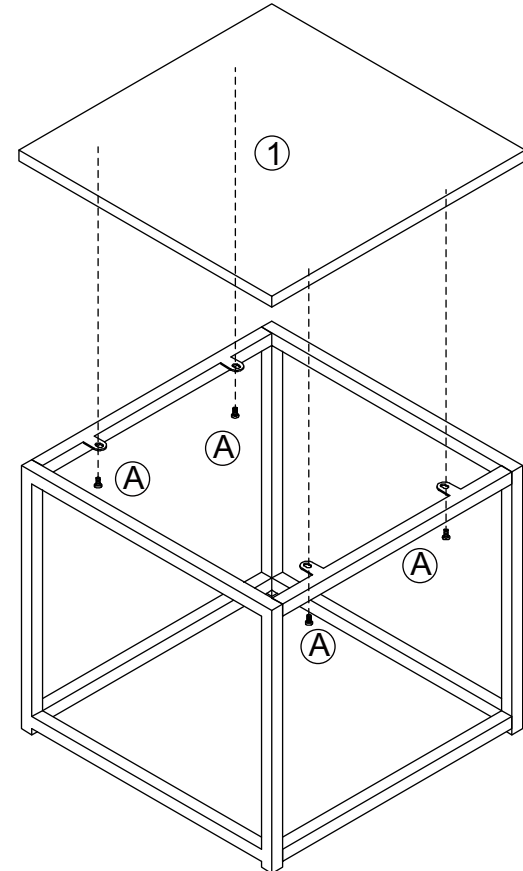

(A) x4

