

CARE AND MAINTENANCE

Spot clean using a mild water-free solvent. Only a professional cleaner should undertake a complete overall cleaning.

The use of steam or water-based cleaners may cause excessive shrinking or staining.





NOTICE

* Please make sure that you have all parts indicated before you begin assembly of this item

* This item should be assembled on a soft surface to prevent scratching the finish during assembly

* This item may require periodic tightening

Part List and Hardware List

PIECE	DESCRIPTION	PICTURE	QUANTITY
A	Seat		1X
B	Back		1X
H1	Flat washer	 Ø16-Ø6	4X
H2	Allen bolt	 M6*20mm	4X
H3	Allen key	 M4	1X



Model# FOX2010

Product Dimensions:17"WX17"D^X30-3/4"H

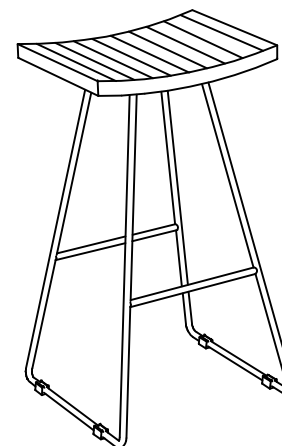

PREPARATION

Before beginning assembly of product, make sure all parts are present. Compare parts with package contents list and hardware contents list.

If any part is missing or damaged, do not attempt to assemble the product .

Estimated Assembly Time: 10 minutes.

Tools Required for Assembly (included): Allen Key

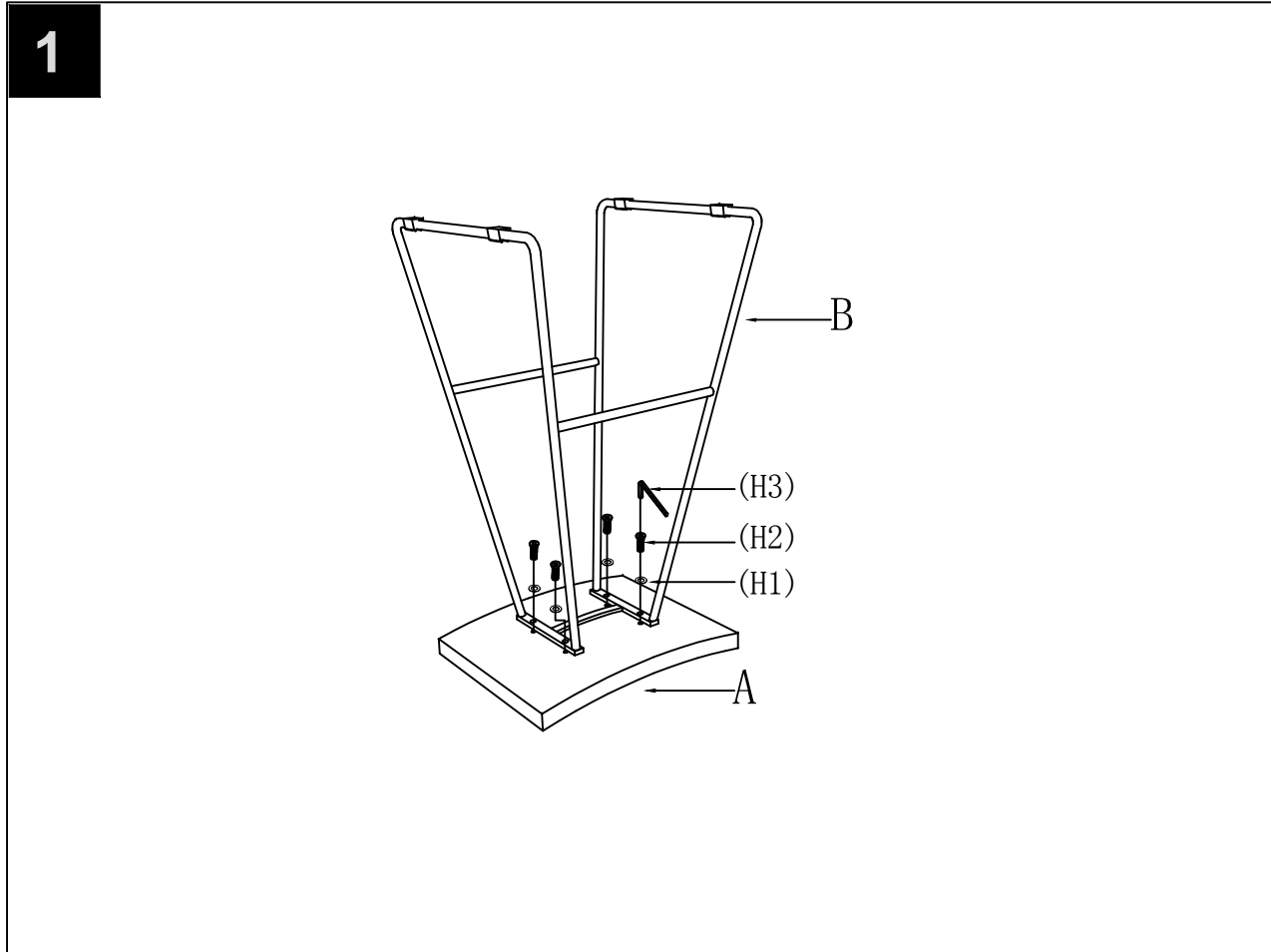

Step 1

Turn the chair frame upside down.

Use Allen wrench H3 to tighten flat washer H1 into bolt H2 to the seat A.