



SAFAVIEH LIGHTING

Assembly Instruction

CAUTION: Read instruction carefully and turn electricity off at main circuit breaker panel before beginning installation.

ITEM#:FLU4004 A / B

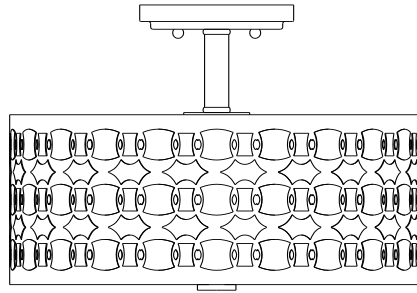

Care and Cleaning









To clean the outside of the fixture, use a dry or slightly dampened clean cloth (use clean water, never a solvent) to wipe the surface of the fixture.

To clear the inside of the fixture, first disconnect power to the fixture by turning off the circuit breaker or by removing the fuse at the fuse box. Next, use a dry or slightly dampened clean cloth (use clean water, never a solvent) to wipe the interior surface of the fixture.

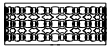
Do not use any cleaners with chemical, solvents or harsh abrasives. Use Only a dry soft cloth to dust or wipe carefully.

Estimated Assembly Time: 30 minutes

Part List and Hardware List

PIECE	DESCRIPTION	PICTURE	QUANTITY	PIECE	DESCRIPTION	PICTURE	QUANTITY
A	Mounting Plate		1X	F	Bulb		3X
B	Wire Nut		3X	G	Shade		1X
C	Mounting Screw		2X	H	Diffuser		1X
D	Canopy		1X	I	Metal Cover		1X
E	Canopy Nut		2X	J	Finial		1X

Installation

Step 1

Unpack all parts from cartons carefully.

Separate the Mounting Plate(A) from the Canopy(D) by removing the Canopy Nut(E) anti-clockwise.

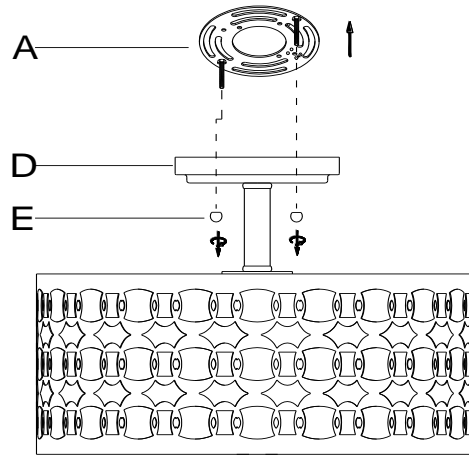

Step 2

Insert the J-box wires through the center opening of Mounting Plate (A)

Attach the Mounting Plate (A) onto the J-box and secure it by turning the 2 Mounting Screws (C) clockwise until tight.

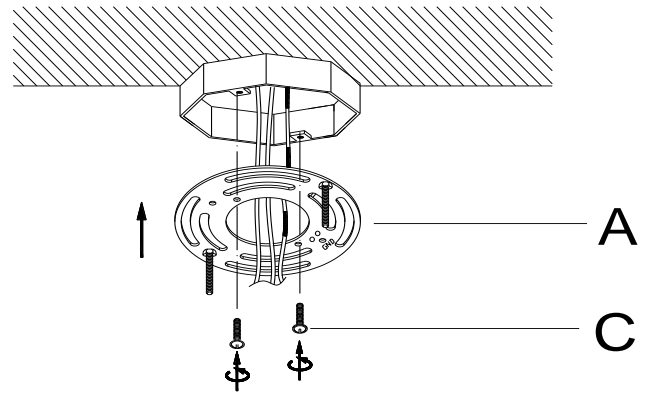

Step 3 Wire connection

Connect, Hot, Black or Red outlet Supply Wire to:	Connect, Neutral, White Outlet Supply Wire to:
Black	White
*Parallel Cord (round & smooth)	*Parallel Cord (square & ridged)
Clear, Brown, Gold or Black without Tracer (colored stripes)	Clear, Brwn, Gold or Black without Tracer (colored stripes)
Insulated Wire (not green) with copper metal conductor	Insulated Wire (not green) with Silver metal conductor

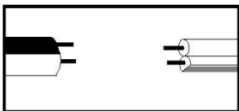

*Note: When parallel wire (SPTI & SPTII) is used. The neutral wire is square shaped and ridged and the hot wire will be round in shape and smooth. (See illustration on left)

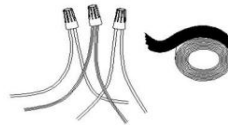

Grounding Instructions:

a) For installation in the United States: Wrap ground wire from outlet box around green ground screw on mounting bracket, no less than 2" from wire end. Tighten ground screw. If fixture is supplied with a ground wire, connect to outlet ground wire with a wire connector.

b) For installation in Canada: If fixture is supplied with ground wire, wrap ground wire around green grounding screw on mounting bracket. Tighten ground screw.

Step 4

Attach the Canopy(D) to the Mounting Plate (A) and fix it by turning the Canopy Nut (E) clockwise.

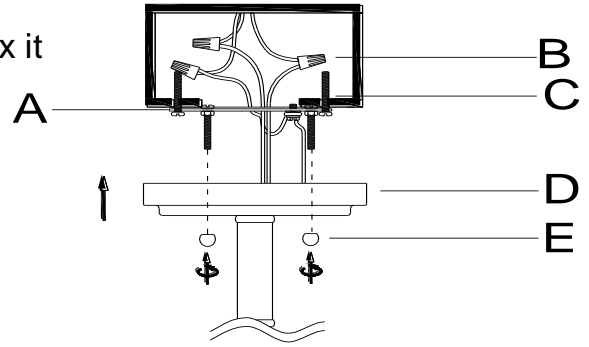

Step 5

Insert the Bulbs (F) into the Socket as diagram.

Place the Diffuser(H) first then the Metal Cover(I) onto the threaded portion of the tube underneath the socket as diagram.

Fix the Diffuser(H) in place by turning the Finial (J) clockwise till tight.

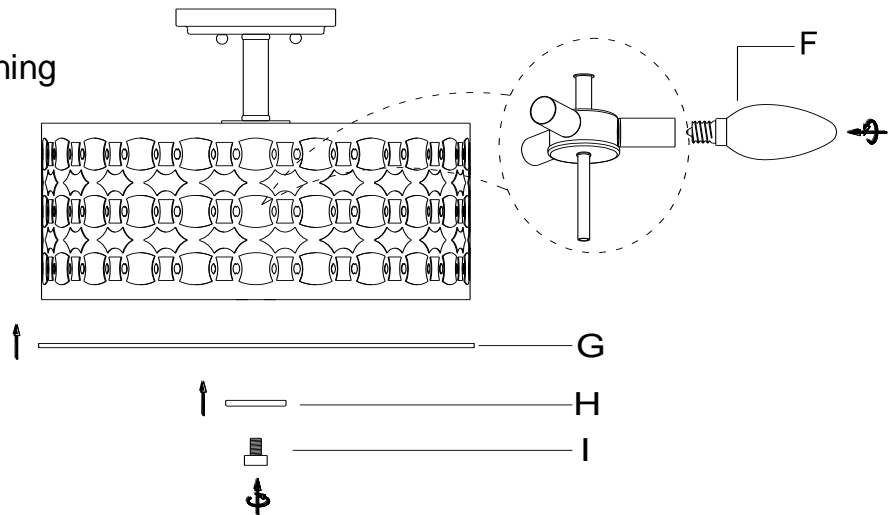

**PLEASE USE TYPE "B" BULB MAX 40-WATT OR CFL BULB MAX 9-WATT
THERE ARE 3 X 25W BULBS IN THE BOX.**

Step 6

Consult a qualified electrician to ensure correct branch circuit conductor

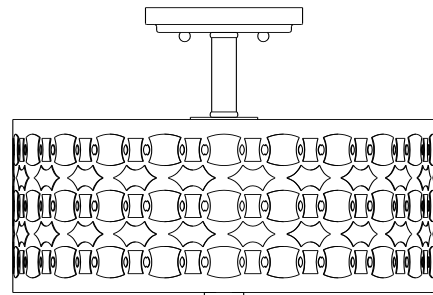

ENJOY YOUR LAMP