

## NOTICE

- \* Please make sure that you have all parts indicated and they are in good condition before you begin assembly of this item. Refer to part list and hardware list below for guidance.
- \* This item should be assembled on a soft surface to prevent scratching the fini
- \*To reduce the risk of fire, electrical shock or injury to persons or property, please follow the below for safe use and installation.
- \*The external flexible cable or cord of this luminaire can not be replaced; If the cord is damaged, the luminaire shall be destroyed.
- \* If you are having difficulty, our friendly Customer Care team is always here to help. Please email [customersupport@safavieh.com](mailto:customersupport@safavieh.com)





## PREPARATION

\*\*This portable lamp has a polarized plug (one blade is wider than the other) as a safety feature to reduce the risk of electric shock. this plug will fit in a polarized outlet only one way. if the plug does not fit fully in the outlet, reverse the plug, if it still does not fit, contact a qualified electrician. Never use with an extension cord unless the plug can be fully inserted. Do not attempt to defeat this safety feature.

## CARE AND MAINTENANCE

Unplug Lamp before using any cleaning solutions. Dust shade with a feather duster as with an appropriate vacuum-brush attachment. Wipe with a soft, dry cloth and clean lamp base with methods appropriate to the material. Avoid the use of chemicals and household cleaners as they may damage the finish.

Part List and Hardware List

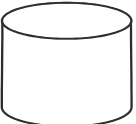
PIECE	DESCRIPTION	PICTURE	QUANTITY	PIECE	DESCRIPTION	PICTURE	QUANTITY
A	Lamp body		1X	C	Lamp body		3X
B	Lamp body		3X	D	Lamp body		3X
E	Lamp Shade		1X				

 **SAFAVIEH**  
LIGHTING

Model # FLL2001A

Product Dimensions : 16"LX16"WX60"H

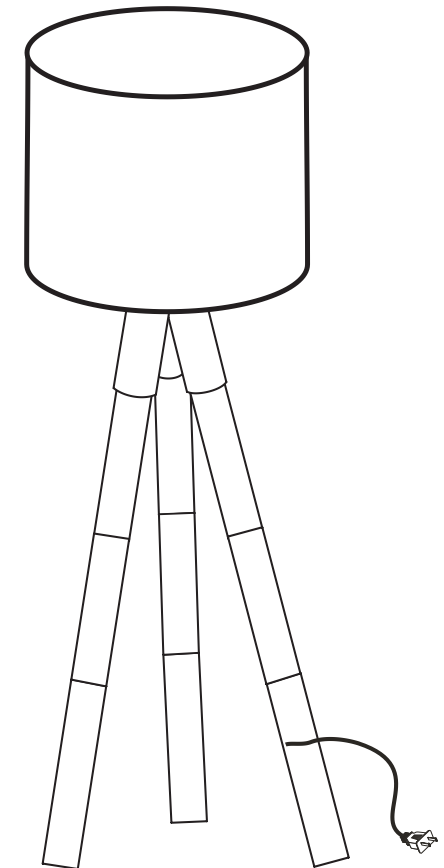

## PREPARATION

- \* Before beginning assembly of product, make sure all parts are present. Compare parts with part contents list and hardware contents list.
- \* If any part is missing or damaged, do not attempt to assemble the product.
- \* Estimated Assembly Time: 10 minutes.
- \* Tools Required for Assembly (included): Harp and Finial
- \* If you are having difficulty, our friendly Customer Care team is always here to help. Please email [customersupport@safavieh.com](mailto:customersupport@safavieh.com)

PLEASE USE ON/OFF TYPE "A" BULB MAX 150-WATT OR CFL BULB MAX 25-WATT

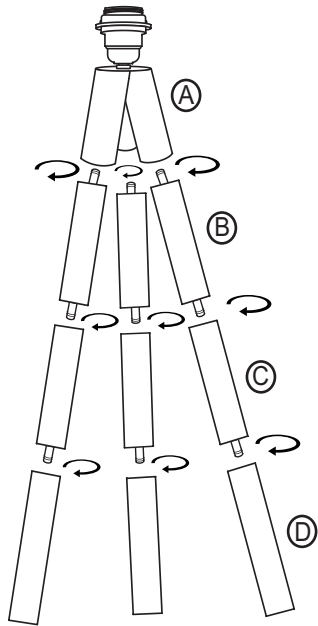

### Step 1

Carefully place Part B over Part C and thread until completely tight. Similarly place Part C over Part D, and thread until tight. Finally thread the long leg (B+C+D) onto Part A.

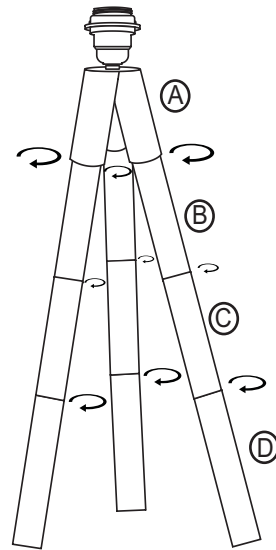

### Step 2

Repeat this process with other 2 legs to completely Lampbody installation.

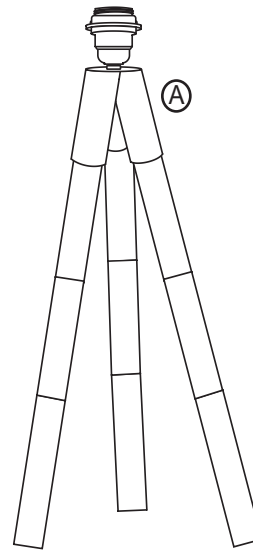

### Step 3

Loosen shade ring on electrical holder and place Cane Lampshade (E) on Part (A). Now thread the shade ring back on the electrical holder to complete the installation.

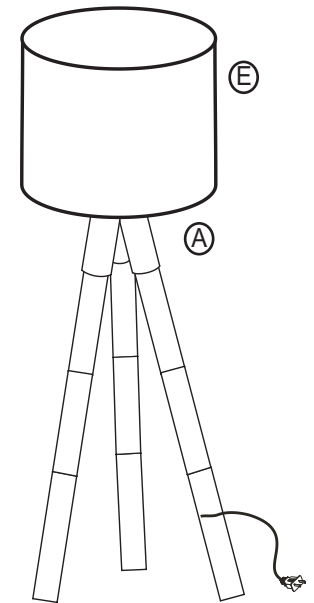

ENJOY YOUR LAMP