

CARE AND MAINTENANCE

Spot clean using a mild water-free solvent. Only a professional cleaner should undertake a complete overall cleaning.

The use of steam or water-based cleaners may cause excessive shrinking or staining.







NOTICE

* Please make sure that you have all parts indicated before you begin assembly of this item

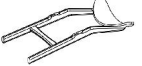
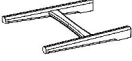
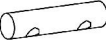
* This item should be assembled on a soft surface to prevent scratching the finish during assembly

* This item may require periodic tightening.

Part List and Hardware List

PIECE	DESCRIPTION	PICTURE	QUANTITY
A	CHAIR SEAT		2X
B	CHAIR BACK		2X
C	FRONT LEG		2X
HW1	BARREL NUT	Ø10x45 	4X
HW2	CROSS BOLT	M6 x 80mm 	8X
HW3	HEADLESS BOLT	M8 x 70mm 	4X
HW4	SEMICIRCLE WASHER	M8 x 30mm 	4X
HW5	NUT	M8 	4X
HW6	ALLEN KEY		1X
HW7	SPANNER		1X



Model# DCH1001

Product Dimensions: 17.3"W x 21.1" D x 33.5" H

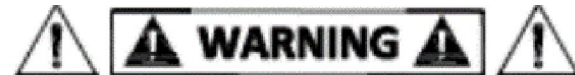
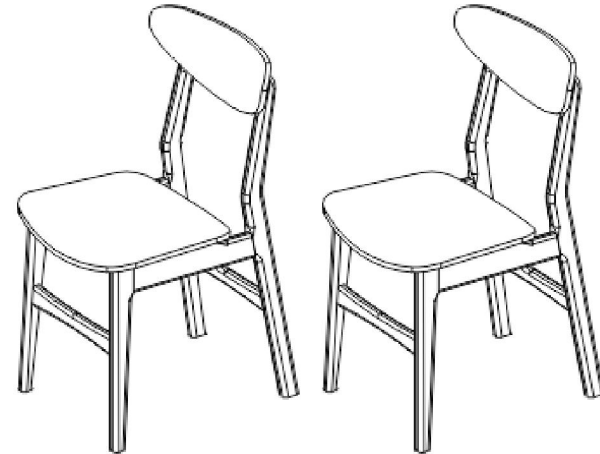

Weight capacity: 275 Lbs

WARNING: DO NOT STAND ON CHAIR

WARNING: DO NOT OVER TORQUE BOLTS

PREPARATION

Before beginning assembly of product, make sure all parts are present. Compare parts with package contents list and hardware contents list.

If any part is missing or damaged, do not attempt to assemble the product.

Estimated Assembly Time: 10 minutes.

Tools Required for Assembly (included):

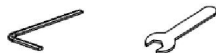

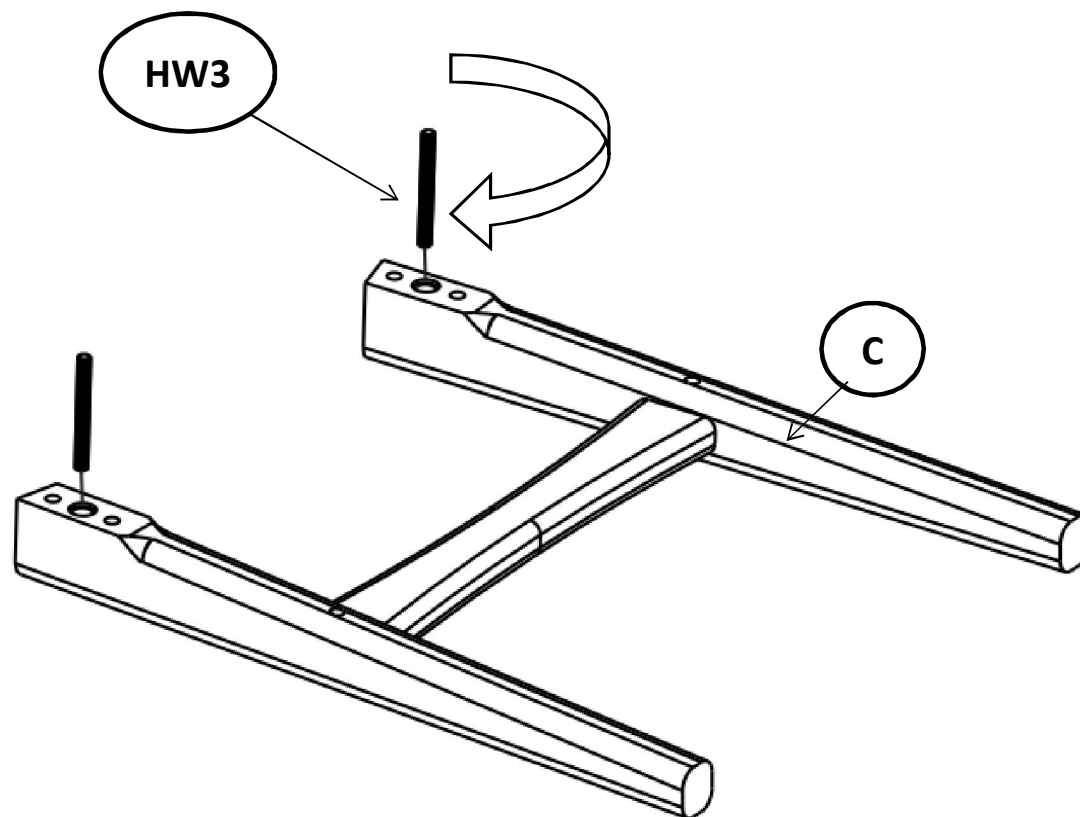

STEP 1

HW3  x 4



STEP2

HW1  x 4
HW2  x 8

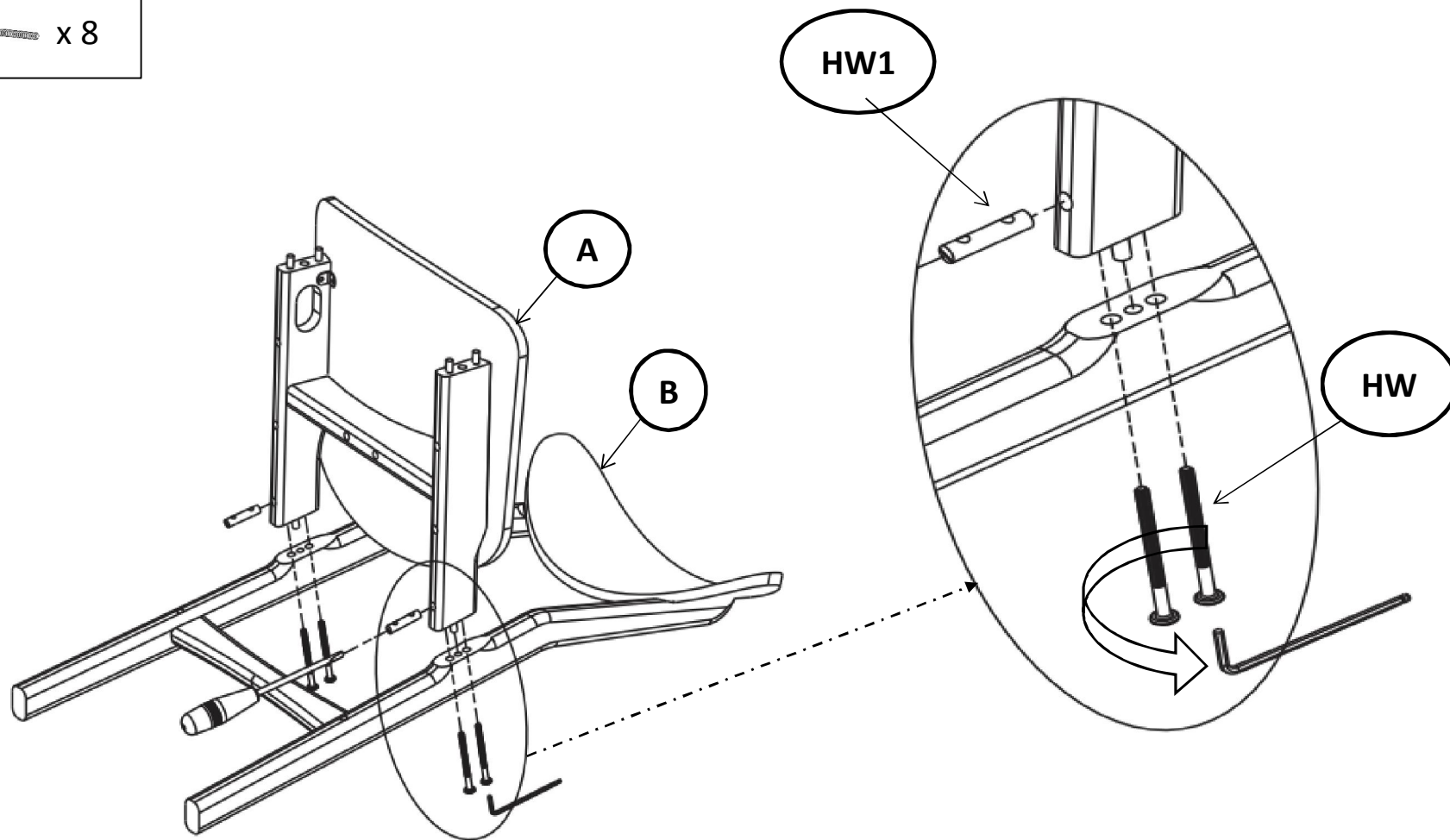

STEP3

- HW4  x 4
- HW5  x 4

