

NOTICE

*Please make sure that you have all parts indicated and they are in good condition before you begin assembly of this item. Refer to part list and hardware list below for guidance.

*This item should be assembled on a soft surface to prevent scratching the finish during assembly.

*This item may require periodic tightening.

*If you are having difficulty, our friendly Customer Care team is always here to help. Please email customersupport@safavieh.com.

PREPARATION

* Before beginning assembly of product, make sure all parts are present. Compare parts with part contents list and hardware contents list.

* If any part is missing or damaged, do not attempt to assemble the product.

* Estimated Assembly Time: 10 minutes.

*Tools Required for Assembly (included): Allen Key

CARE AND MAINTENANCE

Store outdoor furniture indoors or cover well when not in use. Dust regularly with small brush or vacuum. Spills should be taken care of immediately before they harden or stain with a slightly dampened sponge.

WOODCARE

Adhesive felt pads should always be applied to areas of furniture which make direct contact with flooring, said application will prevent damage to the furniture and or surfaces on which the furniture lies. Objects placed on articles of furniture should rest on nonabrasive material as to prevent damage to the wood finish. Objects whose composition consists of plastic and rubber are known to discolor and damage the wood surfaces on which they rest. Wipe up

Cleaning should be done with a soft lint free cotton cloth dampened with water or furniture polish. On highly used surfaces we recommend applying a quality paste wax which should be used on a regular basis to provide additional protection from scratches and spills. How often you apply the wax depends on how much wear the furniture receives.

SAFAVIEH C O U T U R E

Model# CPT1022

Product Dimensions: 31.2" W x 32.8" D x 37.6" H

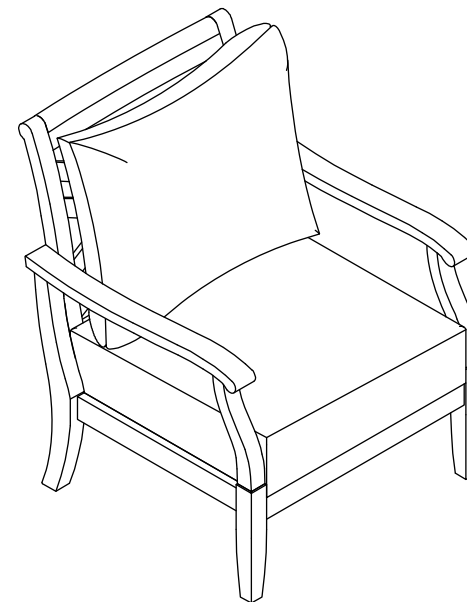

Weight Capacity : 200 lbs

Warning : Do not stand on bench

Warning : Do not over torque bolts / screws

PREPARATION

*Before beginning assembly of product, make sure all parts are present. Compare parts with package contents list and hardware contents list.







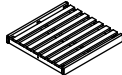

*If any part is missing or damaged, do not attempt to assemble the product.

* Estimated Assembly Time : 10 minutes.

* Tools Required for Assembly (included): Allen Key

* If you are having difficulty, our friendly Customer care team is always here to help. Please email customersupport@safavieh.com

Part List and Hardware List

PIECE	DESCRIPTION	PICTURE	QUANTITY
A	Frame back		1X
B	Frame Seat		1X
C	Right Leg Frame		1X
D	Left Leg Frame		1X
G	Dowel		2X
CSH1	Back Cushion		1X
CSH2	Seat Cushion		1X
HW1	Allen Bolt: M6x0.5x35 mm	 M6x35	2X
HW2	Allen Bolt: M6x0.5x60 mm	 M6x60	8X
HW3	Allen key	 LG4	2X

PREPARATION

- *Before beginning assembly of product, make sure all parts are present. Compare parts with package contents list and hardware contents list.
- *If any part is missing or damaged, do not attempt to assemble the product.
- * Estimated Assembly Time : 10 minutes.
- * Tools Required for Assembly (included): Allen Key
- * If you are having difficulty, our friendly Customer care team is always here to help. Please email customersupport@safavieh.com

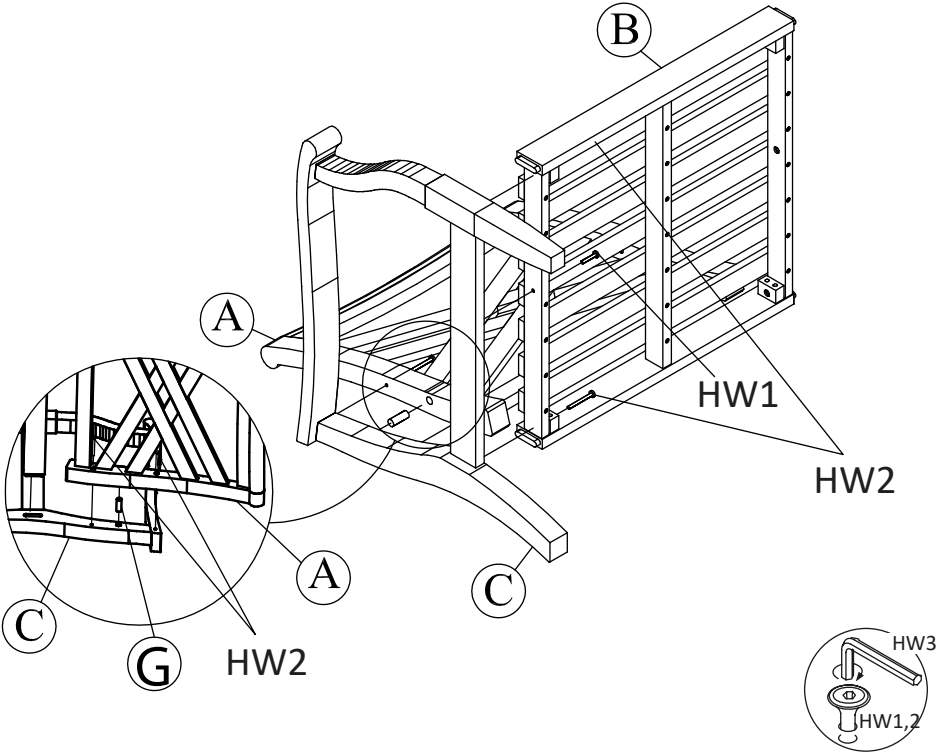
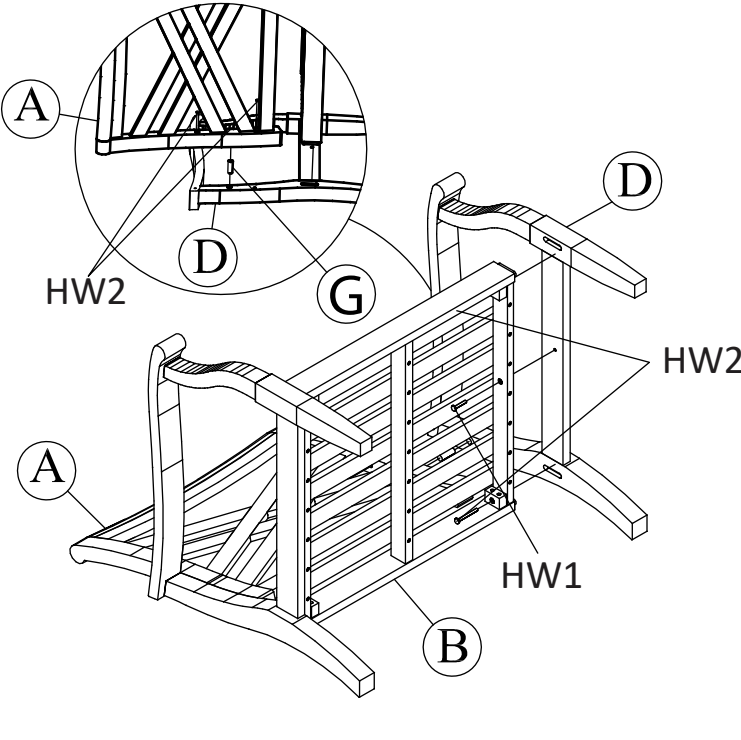
<p>1</p> 	<p>2</p> 
<p>Step 1</p> <p>Attach Right Frame (C) go to Seat Frame (B) & Back Frame (A) by using Dowel(G) Bolt (HW1) and Bolt (HW2) tighten with Allen Key (HW3)</p>	<p>Step 2</p> <p>Attach Right Frame (D) go to Seat Frame (B) & Back Frame (A) by using Dowel(G) Bolt (HW1) and Bolt (HW2) tighten with Allen Key (HW3)</p>

PREPARATION

- *Before beginning assembly of product, make sure all parts are present. Compare parts with package contents list and hardware contents list.
- *If any part is missing or damaged, do not attempt to assemble the product.
- * Estimated Assembly Time : 10 minutes.
- * Tools Required for Assembly (included): Allen Key
- * If you are having difficulty, our friendly Customer care team is always here to help. Please email customersupport@safavieh.com

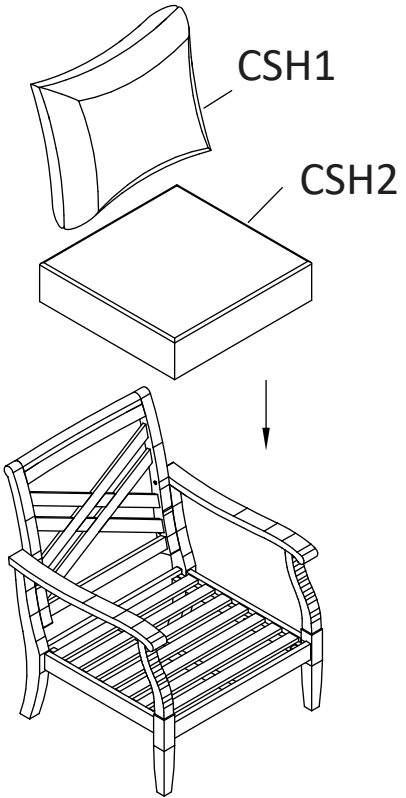
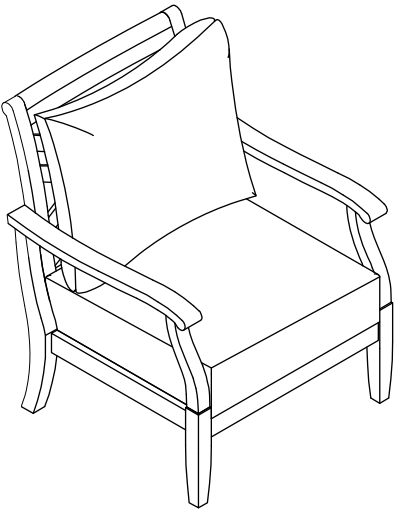
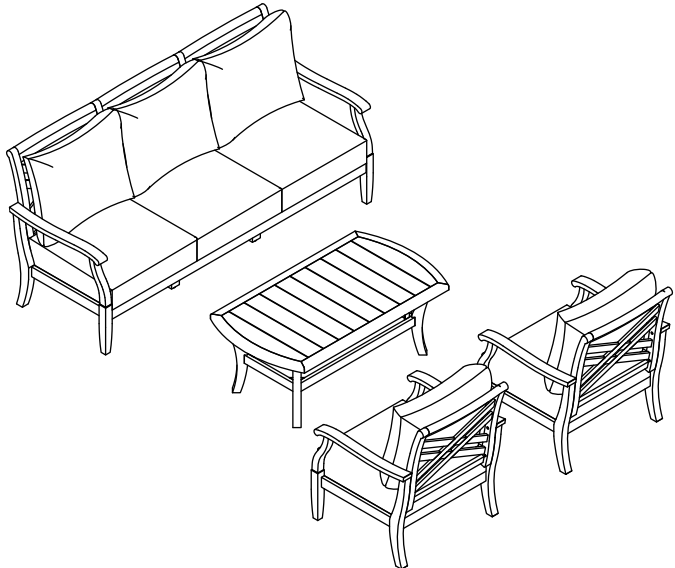
<p>3</p> 	<p>4</p> 	<p>5</p> 
<p>Step 3 Attach Back Cushion (CSH1) and Seat Cushion (CSH2)</p>	<p>Step 4 Finished</p>	<p>Step 5</p>