







## CARE AND MAINTENANCE

Wipe clean with a soft, dry cloth. Test the cleaning method on a hidden area before using them over the entire area.

## NOTICE

- \* Please make sure that you have all parts indicated before you begin assembly of this item.
- \* This item should be assembled on a soft surface to prevent scratching the finished product during assembly.
- \* This item may require periodic tightening.
- \* Do not tighten bolts until completely assembled.

## Part List and Hardware List

PIECE	DESCRIPTION	PICTURE	QUANTITY
A	Longer Shelf		3x
B	Middle Shelf		1x
C	Leg -1		4x
D	Leg -2		4x
HW1	Hex Socket Bolt	 1/4"-20x5/8"	28x
HW2	Allen Key	 M4	1x

 **SAFAVIEH**  
FURNITURE

Model# CNS6204

Product Dimensions: 55"Wx12"Dx30-1/4"H

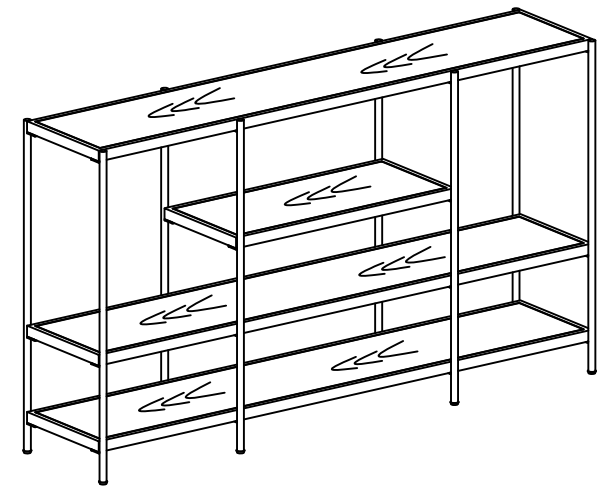

Weight capacity : 25 lbs  
WARNING : DO NOT STAND ON TABLE

## PREPARATION

Before beginning assembly of product, make sure all parts are present. Compare parts with package contents list and hardware contents list. If any part is missing or damaged, do not attempt to assemble the product.

Estimated Assembly Time: 30 minutes.

Tools Required for Assembly (included): Allen Key

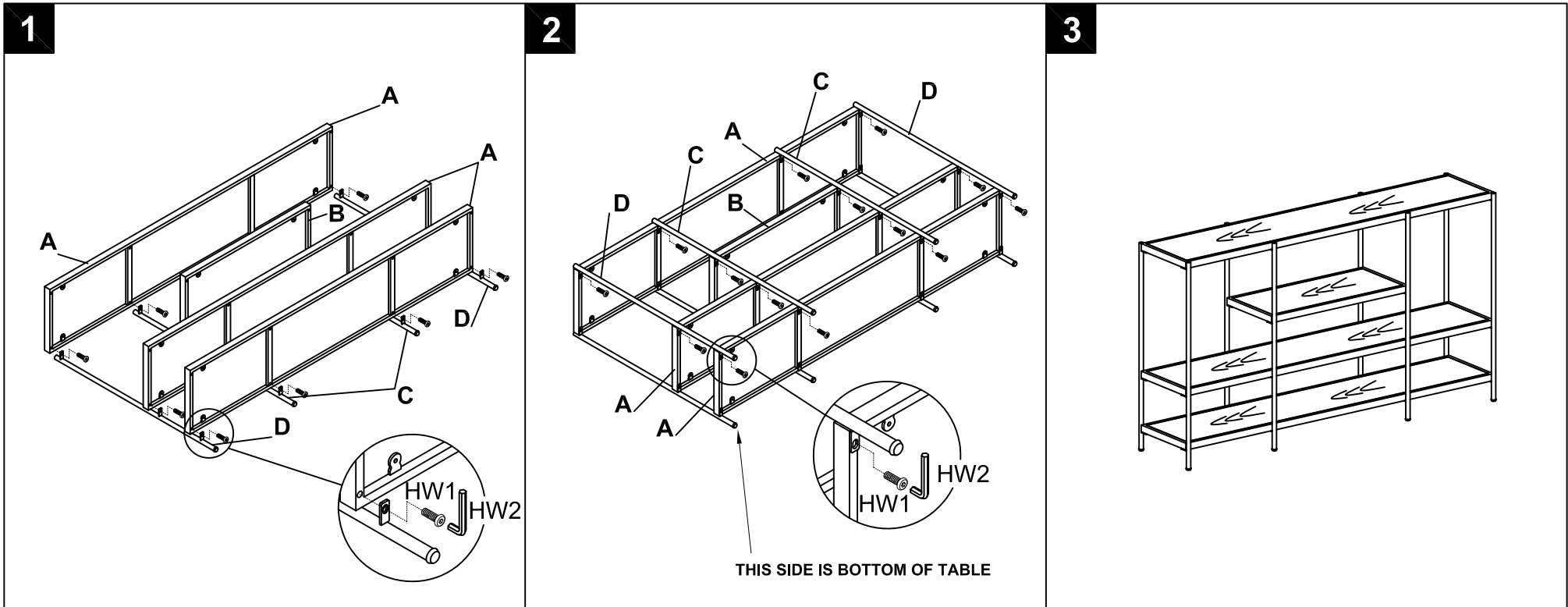

### Step 1

Put 2\*Leg -1 (C) flat in the middle position, and also put 2\*Leg -2 (D) flat on the both sides (left & right) respectively, this side with small metal protrusion welded of leg is facing up to attach the 4\*shelf (A & B) in the corresponding position, and use Allen Key (HW2) to lock 14\*Hex Socket Bolt (HW1), as picture.

### Step 2

Attach rest 4\*Legs (C & D) to the assembled metal frame (as step 1). [another 2\*Leg -1 (C) in the middle position, and another 2\*Leg -2 (D) on the both sides (left & right) respectively] this side with small metal protrusion welded of leg is facing to the assembled metal frame (as step 1), and use Allen Key (HW2) to lock 14\*Hex Socket Bolt (HW1), as picture.

### Step 3

Straighten up the assembled product, assembly is completed.