

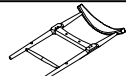

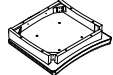

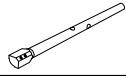



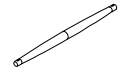
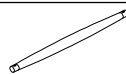

## PREPARATION FOR ASSEMBLY

- \* Before beginning assembly of product, make sure all parts are present and in good condition.
- \* Compare parts with part content list and hardware content list. If any part is missing or damaged, do not attempt to assemble the product.
- \* Estimated assembly time: 15 minutes.
- \* Tools required for assembly: Allen key (included) and screw driver (not included).

### Part List and Hardware List

PIECE	DESCRIPTION	PICTURE	QUANTITY
A	Chair Back		1X
B	Chair Seat		1X
C	Front Leg-1		1X
D	Front Leg-2		1X
E	Front Rail		1X
F	Side Rail-1		1X
G	Side Rail-2		1X
HW1	Socket Bolts M6x1.0x45mm		6X
HW2	Socket Bolts M6x1.0x80mm		4X
HW3	Split Lock Washer 6mm		10X
HW4	Flat Washer 6mm		10X
HW5	Phillips Screws 4x35mm		6X
HW6	Allen Key		1X



Model #: BST1503

Product Dimensions: 21.9" W x 21.1" D x 42"H

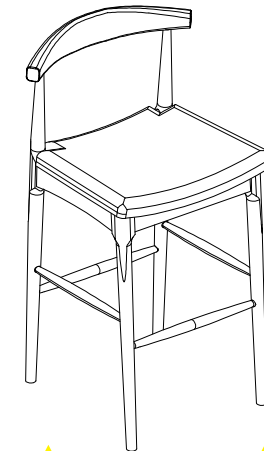

**! WARNING !**

Weight capacity: 275 LBS

Warning: Do not stand on Chair

Warning: Do not over torque Bolts

## NOTICE FOR CARE & MAINTENANCE

- \* This item should be assembled on a soft surface to prevent scratching the finish during assembly.
- \* This item may require periodic tightening.
- \* If you are having difficulty, our friendly Customer Care team is always here to help. Please email [customersupport@safavieh.com](mailto:customersupport@safavieh.com)

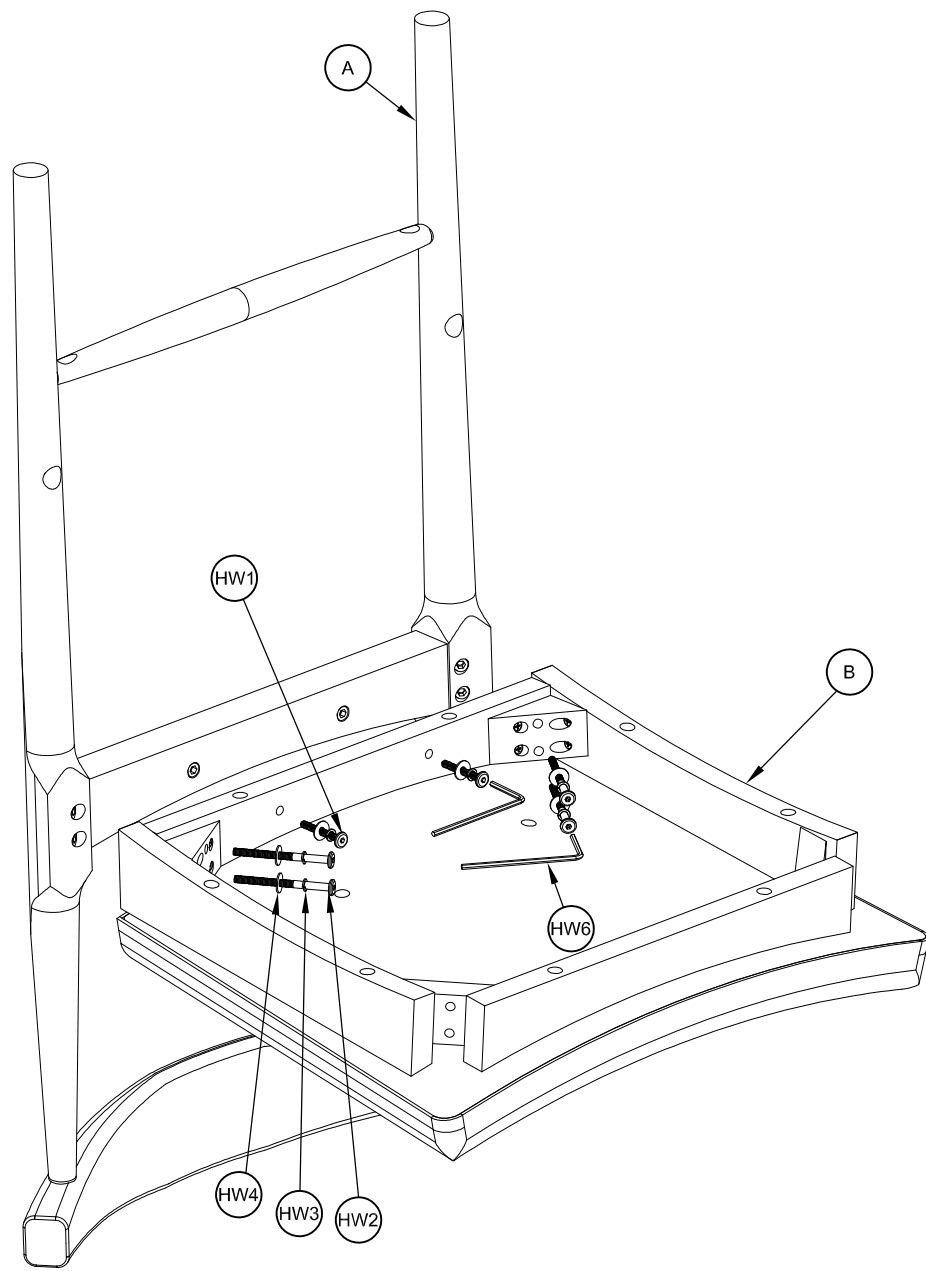

STEP 1: Attach the seat to the chair back. Make sure to apply all the bolts into the holes properly before tightening.

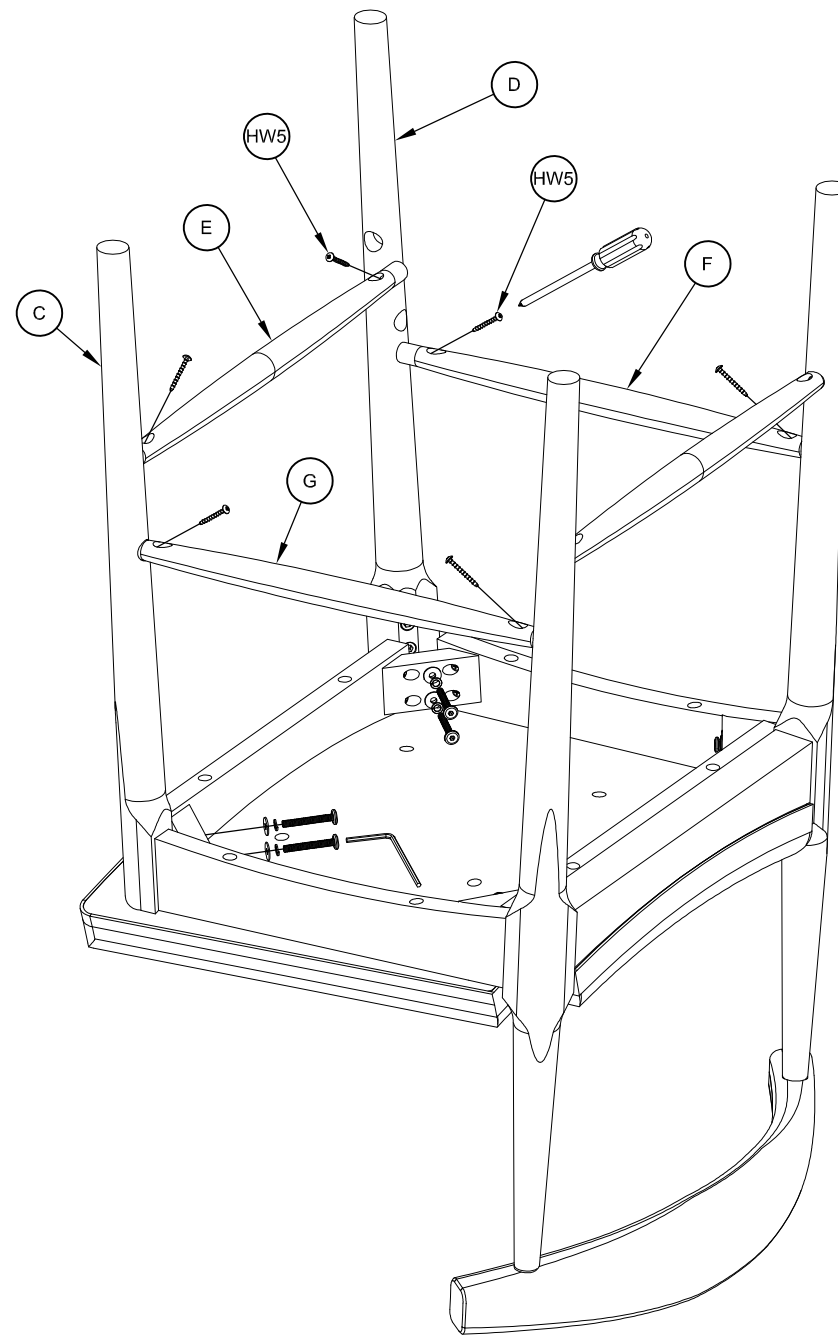

STEP 2: Attach the front legs, front rail and side rails as illustrated in picture. Make sure to apply all the bolts into the holes properly before tightening.