

## CARE AND MAINTENANCE

TO PREVENT OVERALL SOILING, FREQUENT VACUUMING OR LIGHT BRUSHING IS RECOMMENDED. CUSHIONS AND PILLOWS SHOULD BE TURNED ON A WEEKLY BASIS. DOWN-FILLED CUSHIONS SHOULD BE BRUSHED RATHER THAN VACUUMED. SPOT CLEAN, USING A MILD WATER-FREE SOLVENT OR DRY CLEANING PRODUCT. ONLY A PROFESSIONAL CLEANER SHOULD UNDERTAKE A COMPLETE OVERALL CLEANING. THE USE OF STEAM OR WATER-BASED CLEANERS MAY CAUSE EXCESSIVE SHRINKING OR STAINING.

## NOTICE

\*PLEASE MAKE SURE THAT YOU HAVE ALL PARTS INDICATED BEFORE YOU BEGIN ASSEMBLY OF THIS ITEM

\*THIS ITEM SHOULD BE ASSEMBLED ON A SOFT SURFACE TO PREVENT SCRATCHING THE FINISH DURING ASSEMBLY

\*THIS ITEM MAY REQUIRE PERIODIC TIGHTENING





 **SAFAVIEH**  
FURNITURE

Item# ACH7002A

Product Dimensions: 22"W X 22"D X 31.9"H

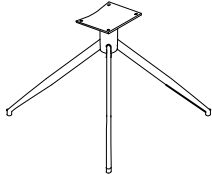
WEIGHT CAPACITY: 275 LBS

## Part List

PIECE	DESCRIPTION	PICTURE	QUANTITY
A	SEAT		1X
B	BASE		1X
C	SCREW		4X <sub>M6*20mm</sub>
D	WASHER		4X <sub>M6</sub>
E	ELLEN KEY		1X



## PREPARATION

BEFORE BEGINNING ASSEMBLY OF PRODUCT, MAKE SURE ALL PARTS ARE PRESENT. COMPARE PARTS WITH PACKAGE CONTENTS LIST IF ANY PART IS MISSING OR DAMAGES, DO NOT ATTEMPT TO ASSEMBLE THE PRODUCT.  
ESTIMATED ASSEMBLY TIME: 5 MINUTES.

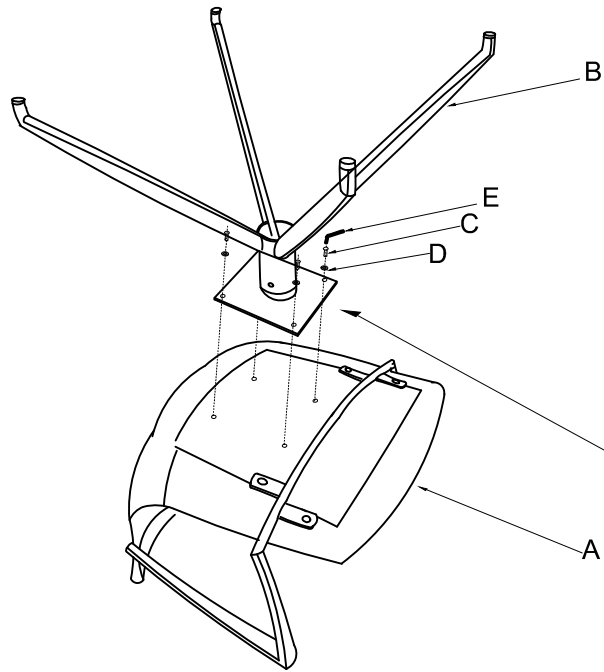

STEP 1

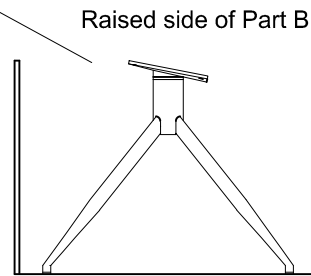

ATTACH THE RAISED SIDE OF PART B TO THE FRONT OF PART A SO THAT THE RAISED SIDE OF PART B IS PLACED TOWARDS THE FRONT OF THE SEAT.

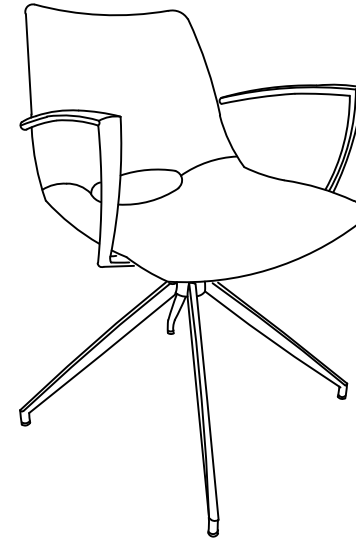

STEP 2